

Pentra 80 Range

Hematology Analyzer

Output Formats

Ref: RAA040DEN

Foreword

Table of Contents

Section 1: [Foreword](#) [page 2](#)

Section 2: [Introduction](#) [page 3](#)

Section 3: [Connection](#) [page 4](#)

Section 4: [ASTM Format](#) [page 6](#)

Section 5: [ABX Format](#) [page 20](#)

Revisions

Part number	Software version			Chapters	Date
	ABX Pentra 80	ABX Pentra XL80	Pentra XLR		
RAA040CEN	V 1.12.x	V 1.11.x	V 2.0.x	All	June 2013
RAA040DEN	V 1.12.x	V 2.2.x	V 2.2.x	All	April 2014

Introduction

The ASTM Format is recommended by HORIBA Medical for every new connection development. The ABX Format is currently supported to be compliant with existing connections but it will not be supported on future generations of instruments. The Argos Format is not supported on new systems.

Different protocols can be used on HORIBA Medical instruments. A connection between a computer (host) and an HORIBA Medical instrument can be performed when the protocol, the format description and the connection mode have been properly set up.

Table 1: Definitions

Term	Definition
<ACK>	Acknowledgment (ASCII Decimal 6).
[C1]	The most significant character of Checksum.
[C2]	The least significant character of Checksum.
[DATA]	The data contents of the record.
<ENQ>	Inquire (ASCII Decimal 5).
<ETB>	End of Transmission Block (ASCII Decimal 23). For use only when a single record is too large to fit into one frame.
<ETX>	End of Text (ASCII Decimal 3). Required at the end of each record.
[frame number]	Single digit frame number "0" to "7", starts with "1".
<LF>	Line Feed (ASCII Decimal 10).
<NAK>	Negative Acknowledgment (ASCII Decimal 21).
<STX>	Start of Frame (ASCII Decimal 2).
Communications packet	All framing required for transmission of data. This framing includes: <STX>[frame number][DATA] [<ETB> or <ETX>][C1][C2] <LF>.
Component Field	One of several related pieces of information within a field.
Field	A specific location within a record for a piece of information, indicated by a field delimiter and position.
Frame	A complete communications packet.
LIS	Laboratory Information System.
Message	A collection of related information; a group of records that begins with a "Header" record and ends with a "Terminator" record. A single record could theoretically constitute a message, but within this context, a message always contains multiple records.
<EOT>	End of Transmission (ASCII decimal 4).

Table 1: Definitions

Term	Definition
<CR>	Carriage Return (ASCII decimal 13).
Record	In reference to the low level protocol, a record is the message data (shown as [DATA]) as described within the communications packet. If the data is longer than 240 characters, then it must be split into two (or more) parts and sent in two (or more) communications packets. The intermediate packet uses the <ETB> character, and the ending packet uses the <ETX> character. No single communications packet contains more than one record. In reference to the message layer, a record can be one of the following codes: H (header), P (patient), O (order), R (result), L (terminator), C (comment).
Session	A total unit of communication activity used in this standard to indicate the events starting with the Establishment phase and ending with the Termination phase.
Test	A determination of a single analyte or a combination of values from other determinations or observations from which a variable or gradable result is derived.

Connection

Serial (RS232)

1. Physical Layer

- GND: ground
- TXD: transmission
- RXD: reception

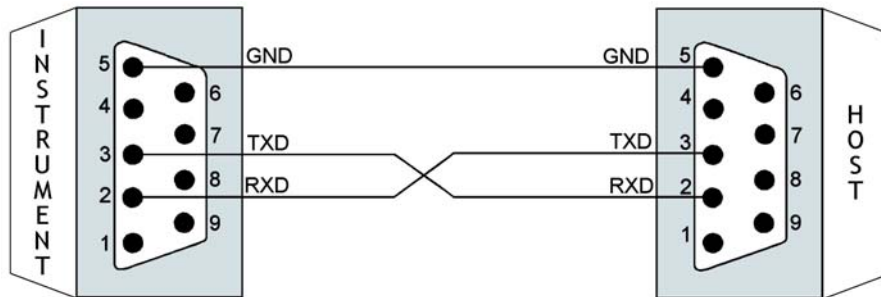

The cable between the connectors must be shielded.

2. Format compatibility

Table 2: Format compatibility according to HORIBA Medical analyzers and types of analysis

Analysis types	ABX Pentra 80		ABX Pentra XL80		Pentra XLR	
	ABX	ASTM	ABX	ASTM	ABX	ASTM
Receive Orders	X	X	X	X	X	X
TSO mode	X	X	X	X	X	X
Query	X	X	X	X	X	X
CBC	X	X	X	X	X	X
DIFF (CBC+DIFF)	X	X	X	X	X	X
RET					X	X
DIR (DIFF+RET)					X	X



It is possible to keep the compatibility with the ABX Pentra 80 on the ABX Pentra XL80 and the Pentra XLR.

Ethernet connection

(ABX Pentra XL80 and Pentra XLR in ASTM mode)

You can access and set up ethernet parameters by entering the ABX Pentra XL80 or the Pentra XLR menu: **Settings > System > Communication**

If the "Network Settings" tab is not available on screen, make sure the ASTM mode is selected in the "General" tab.

1. FTP Mode

The instrument starts the connection with the FTP server right before it sends the file, then it is disconnected. Every file sent execute one connection, the same named file must not be on the server when the instrument tries to transfer the file, the Host has to manage the previous sent file.

The files are sent under name "RESXXXXX.AST".

"RESXXXXX.AST" is incremented from 00000 to 99999.

Each line of file "RESXXXXX.AST" is a "Record" according to ASTM format.

A "Record" has no checksum.

Table 3: FTP mode

Analysis types	ABX Pentra XL80	Pentra XLR
CBC	X	X
DIFF (CBC+DIFF)	X	X
DIR (DIFF+RET)		X

2. UDP Mode

Host UDP socket must be set up with:

- Instrument IP address or DNS address
- The Port number where Instrument is awaiting connection

Instrument UDP socket must be set up with:

- Host IP address or DNS address
- The Port number where Host is awaiting connection

The data format is according to ASTM protocol.

3. TCP Mode

Host TCP socket must be set up with (Host is always server):

- Port number where Instrument is connected

Instrument TCP socket must be set up with (Instrument is always client):

- Host IP address or DNS address
- the Port number where Host is awaiting connection

The data format is according to ASTM protocol.

Table 4: UDP and TCP modes

Analysis types	ABX Pentra XL80	Pentra XLR
Receive Orders	X	X
TSO mode	X	X
Query	X	X
CBC	X	X
DIFF (CBC+DIFF)	X	X
DIR (DIFF+RET)		X

ASTM Format

HORIBA Medical instruments format responds to the ASTM specifications E-1381 and E-1394:

- E-1381: Standard specification for Low Level protocol to transfer messages between clinical and laboratory instruments and computer systems.
- E-1394: Standard specification for transferring Information between clinical and laboratory instruments and computer systems.

1. Connection specifications (ASTM E-1381)

1.1. Hardware and software characteristics

Default format for emitted character is 1 bit start, 8 data bits, No parity, 1 bit stop.
Default communication speed is 38400 bauds.

Hardware setting of the interface: Plug A&B are DB9 male plugs.

1.2. Output data characteristics

Characters: ASCII
Maximum message length: 247 characters.
Analyzer manages Xon/Xoff protocol.

1.3. Communication protocol

Table 5: Standard control characters

Control String	Hexadecimal value
<ENQ>	\$05
<ACK>	\$06
<NAK>	\$15
<STX>	\$02
<ETX>	\$03
<CR>	\$0D
<LF>	\$0A
<EOT>	\$04

1.3.1. Instrument/Host connexion

Table 6: Typical discussion between Instrument and Host

Instrument	<>	Host
<ENQ>	>	
	<	<ACK>
<STX>1...Data...<CR><ETX>xx<CR><LF>	>	
	<	<ACK>
<STX>2...Data...<CR><ETX>xx<CR><LF>	>	
	<	<ACK>
<EOT>	>	

Table 7: Typical discussion between Host and Instrument

Instrument	<>	Host
	<	<ENQ>
<ACK>	>	
	<	<STX>1...Data...<CR><ETX>xx<CR><LF>
<ACK>	>	
	<	<STX>2...Data...<CR><ETX>xx<CR><LF>
<ACK>	>	
	<	<EOT>

1.3.2. Discussion with conflict between Instrument and Host

Number of transmission if negative answer (NAK): 6
Timeout if no response: 15 s (Automatic disconnection max. time)
Retry timeout: Variable < 30 s
Special timing: None
Description of other specific treatments: None

In case of ENQENQ conflict analyzer waits 2 s and tries emission again.

Analyzer is master in case of conflict.

Table 8: Discussion with conflict between Instrument and Host

Instrument	<>	Host
<ENQ>	>	
	<	<ENQ>
Wait 2 seconds...		
<ENQ>	>	
	<	<ACK>
<STX>1...Data...<CR><ETX>xx<CR><LF>	>	
	<	<ACK>
<STX>2...Data...<CR><ETX>xx<CR><LF>	>	
	<	<ACK>
<EOT>	>	

1.3.3. Defect packet during discussion between Instrument and Host

Table 9: Defect packet during discussion between Instrument and Host

Instrument	<>	Host
<ENQ>	>	
	<	<ACK>
<STX>1...Data...<CR><ETX>xx<CR><LF>	>	
	<	<NAK>
<STX>1...Data...<CR><ETX>xx<CR><LF>	>	
	<	<ACK>
<STX>2...Data...<CR><ETX>xx<CR><LF>	>	
	<	<ACK>
<EOT>	>	

1.4. ASTM Data frame format

A sequential number located after the <STX> character is inserted into each Data frame. Frame number is set to 1 when transfer phase is initialized and is incremented by 1 for each frame up to 7 and then returns to 0.

Frame number is to permit receiver to distinguish between new and retransmitted frame, in case of retransmitted frame (after a <NAK> response from Host), frame number is not

incremented: <STX>1...Data...<CR><ETX>xx<CR><LF>

Table 10: Frame format:

ASTM field	Definition	Transmitted data	# of bytes	Comments
0	STX	\$02	1	
1	Frame number	1 to 7, 0, ...	1	Frame number is set to 1, incremented by 1 for each frame up to 7, and then returns to 0
2	Data message		240 max.	Header, Patient, Order, Result & Comment messages
3	End of data message ETX if end frame		1	
4	Checksum		2	
5	CRLF	\$0D \$0A	2	

1.4.1. Frame checksum

According to ASTM E-1381 frame checksum (<STX>1...Data...<CR><ETX>xx<CR><LF>) is defined as modulo 256 of ASCII values sum between <STX> not included and <ETX> included characters: 1...Data...<CR><ETX>

2. Records general format specifications (ASTM E-1394)

Data frames encapsulate Records defined by ASTM E-1394 norm, Records themselves encapsulate ASTM fields.

Example of record inside Data frame: <STX>1...Data...<CR><ETX>xx<CR><LF>

<STX>1H|^&|||HostSimulator|||ABX|P|E1394-97|20020705144108<CR><ETX>D3<CR><LF>

Table 11: ASTM Records

Record ID	ASTM Definition	ABX Pentra 80	ABX Pentra XL80	Pentra XLR
H	Header	X	X	X
P	Patient	X	X	X
O	Order	X	X	X

Table 11: ASTM Records

Record ID	ASTM Definition	ABX Pentra 80	ABX Pentra XL80	Pentra XLR
R	Result	X	X	X
C	Comment	X	X	X
Q	Query (Request information order)		X	X
S	Scientific Record			
M	Manufacturer information			
L	Terminator record	X	X	X

2.1. Structure of Records

2.1.1. Structure of records for Order transmission

- H (Header)
- P (Patient)
- C (Patient Comments) Optional
- .. O (Order)
- .. C (Order Comments) Optional
- L (Terminator)

The transmission of an Order without Patient Record is not allowed, but Patient Record can be empty. Example: <STX>2P|1<CR><ETX>BB<CR><LF>

2.1.2. Instrument Patient file modification by Host

- H (Header)
- P (Patient)
- C (Patient Comments) Optional
- L (Terminator)

2.1.3. Structure of records for Result transmission

- H (Header)
- P (Patient)
- C (Patient Comments) Optional
- .. O (Order)
- .. C (Order Comments) Optional

- .. C (Run Alarms) Optional
- R (Result)
- C (Flag Result) Optional
- R (Result)
- C (Flag Result) Optional
-
-
- R (Result)
- C (Flag Result) Optional
- L (Terminator)

2.2. Description of Records

- Only fields described with their specified length are used by HORIBA Medical instruments.
- Length of field can be less than maximum value but must not be more.
- Only “Sample ID” and “Test” fields from Order record must be informed, all other fields are optionals.
- Delimiters must be used even if field is free.
- Delimiters inside records are separate by “|” (ASCII \$7C).
- Delimiters inside fields are separate by “^” (ASCII \$5E).

2.2.1. Header record

Table 12: Header record fields

ASTM field	Definition	Transmitted data	Field max length		
			ABX Pentra 80	ABX Pentra XL80	Pentra XLR
7.1.1	Record Type	H	1	1	1
7.1.2	Delimiters definition	idem standard: Field delimiter \ Repeat delimiter ^ Component delimiter & Escape delimiter	4	4	4
7.1.3	Message Control ID				
7.1.4	Access Password				
7.1.5	Sender Name	LIS	3	3	3

Table 12: Header record fields

ASTM field	Definition	Transmitted data	Field max length		
			ABX Pentra 80	ABX Pentra XL80	Pentra XLR
7.1.6	Sender Address				
7.1.7	Reserved				
7.1.8	Sender Telephone Nb				
7.1.9	Characteristics of Sender				
7.1.10	Receiver ID				
7.1.11	Comments or Special Instructions				
7.1.12	Processing ID	P	1	1	1
7.1.13	ASTM Version Nb	E 1394-97	9	9	9
7.1.14	Date and Time of message	YYYYMMDDHHMMSS	14	14	14

2.2.2. Patient record

Table 13: Patient record fields

ASTM field	Definition	Transmitted data	Field max length			Note
			ABX Pentra 80	ABX Pentra XL80	Pentra XLR	
8.1.1	Record Type	P	1	1	1	
8.1.2	Sequence Nb	1, 2, ...	2	2	2	
8.1.3	Practice Assigned Patient ID					
8.1.4	Laboratory Assigned Patient ID	Patient Id (Advised on ABX Pentra XL80 for workflow management)	25	25	25	

Table 13: Patient record fields

ASTM field	Definition	Transmitted data	Field max length			Note
			ABX Pentra 80	ABX Pentra XL80	Pentra XLR	
8.1.5	Patient ID No	3				
8.1.6	Patient Name	Name^First name	20	41	41	
8.1.7	Mother's Maiden Name					
8.1.8	Birthdate	YYYYMMDD	8	8	8	
8.1.9	Patient Sex	M, F or U	1	1	1	1
8.1.10	Patient Race-Ethnic Origin					
8.1.11	Patient Address					
8.1.12	Reserved					
8.1.13	Patient Telephone Nb					
8.1.14	Attending Physician ID	Text	20	20	20	
8.1.15	Special Field 1					
8.1.16	Special Field 2					
8.1.17	Patient Height					
8.1.18	Patient Weight					
8.1.19	Patient's Known or Suspected Diagnosis					

Table 13: Patient record fields

ASTM field	Definition	Transmitted data	Field max length			Note
			ABX Pentra 80	ABX Pentra XL80	Pentra XLR	
8.1.20	Patient Active Medication					
8.1.21	Patient's Diet					
8.1.22	Practice Field 1					
8.1.23	Practice Field 2					
8.1.24	Admission and Discharge Dates					
8.1.25	Admission Status					
8.1.26	Location	Text	20	20	20	
8.1.27	Nature of Alternative Diagnostic Code and Classifiers					
8.1.28	Nature of Alternative Diagnostic Code and Classifiers					
8.1.29	Patient Religion					
8.1.30	Marital status					
8.1.31	Isolation Status					
8.1.32	Language					

Table 13: Patient record fields

ASTM field	Definition	Transmitted data	Field max length			Note
			ABX Pentra 80	ABX Pentra XL80	Pentra XLR	
8.1.33	Hospital Service					
8.1.34	Hospital Institution					
8.1.35	Dosage Category					



Note 1: M: Male, F: Female, U: Unspecified (If instrument receives an empty field (blank), it uses Unspecified type).

2.2.3. Order record

Table 14: Order record fields

ASTM field	Definition	Transmitted data	Field max length			Note
			ABX Pentra 80	ABX Pentra XL80	Pentra XLR	
9.4.1	Record Type	O	1	1	1	
9.4.2	Sequence Nb	1, 2, ...	2	2	2	
9.4.3	Sample ID		16	22	22	2
9.4.4	Instrument Specimen ID					
9.4.5	Universal Test ID	^^^Test name (CBC, DIFF or DIR)	6	6	6	3
9.4.6	Priority					
9.4.7	Requested/ Ordered Date and Time					

Table 14: Order record fields

ASTM field	Definition	Transmitted data	Field max length			Note
			ABX Pentra 80	ABX Pentra XL80	Pentra XLR	
9.4.8	Specimen Collection Date and Time	YYYYMMDDHHMMSS	14	14	14	
9.4.9	Collection End Time	YYYYMMDDHHMMSS	14	14	14	
9.4.10	Collection Volume					
9.4.11	Collector ID					
9.4.12	Action Code					
9.4.13	Danger Code					
9.4.14	Relevant Clinical Information					
9.4.15	Date/Time Specimen Received					
9.4.16	Specimen Descriptor	Text	20	20	20	
9.4.17	Ordering Physician					
9.4.18	Physician Tel Nb					
9.4.19	User Field 1					
9.4.20	User Field 2					
9.4.21	Laboratory Field 1					
9.4.22	Laboratory Field 2					
9.4.23	Date and Time Results reported or last modified					

Table 14: Order record fields

ASTM field	Definition	Transmitted data	Field max length			Note
			ABX Pentra 80	ABX Pentra XL80	Pentra XLR	
9.4.24	Instrument Charge to Computer System					
9.4.25	Instrument Section ID					
9.4.26	Report Types	F: final C: correction	1	1	1	4
9.4.27	Reserved					
9.4.28	Location or Ward of Specimen Collection					
9.4.29	Nosocomial Infection Flag					
9.4.30	Specimen Service					
9.4.31	Specimen institution					



Note 2: Field 9.4.3 “Sample ID” for ABX Pentra XL80 and Pentra XLR (Only from Instrument to Host) is presented as follows:

SampleID^Rack(2 digits max.)^TubePosition(2 digits max.), Ex. 45264012^02^08

For ABX Pentra 80, the field does not provide any information on the rack. Using the compatibility mode on ABX Pentra XL80 or Pentra XLR will send this field as if it was an ABX Pentra 80.

Note 3: Field 9.4.5 “Universal test ID” must be filled by the parameters panel requested (CBC, DIFF or DIR): Refer to [Special characteristics for HORIBA Medical data](#) on page 14.).

Note 4: Field 9.4.26 “Report type” on ABX Pentra XL80 and Pentra XLR depends on instrument unconditional validation mode state.

If results are unconditionally validated:

- F: Result validated
- I: Result unvalidated

If not:

- F: First result
- C: Resampling

2.2.4. Result record

Table 15: Result record fields

ASTM field	Definition	Transmitted data	Field max length			Note
			ABX Pentra 80	ABX Pentra XL80	Pentra XLR	
10.1.1	Record Type	R	1	1	1	
10.1.2	Sequence Nb	1, 2, ...	2	2	2	
10.1.3	Universal Test ID	^^^Result name in english^LOINC code	15	15	15	5
10.1.4	Data or Measurement Value	Test result (Refer to Special characteristics for HORIBA Medical data on page 14.)				

Table 15: Result record fields

ASTM field	Definition	Transmitted data	Field max length			Note
			ABX Pentra 80	ABX Pentra XL80	Pentra XLR	
10.1.5	Unit or Set of units (P80 V1.1 and above/ PXL80)	1, 2, 3 or 4	1	1	1	
10.1.6	Reference Range					
10.1.7	Result Abnormal Flag	Analytical flag L,H,LL,HH,>	2	2	2	
10.1.8	Nature of Abnormality Testing					
10.1.9	Result Status	W: suspicion N: rejected result F: final result X: Parameter exceeding the capacity (ABX Pentra 80 / ABX Pentra XL80 / Pentra XLR) M: Value input manually (ABX Pentra XL80 / Pentra XLR) D: Value obtained by dilution (ABX Pentra XL80 / Pentra XLR)	1	3	3	6
10.1.10	Date of Change in Normative Values or Units					
10.1.11	Operator Identification	Operator Code + Name				

Table 15: Result record fields

ASTM field	Definition	Transmitted data	Field max length			Note
			ABX Pentra 80	ABX Pentra XL80	Pentra XLR	
10.1.1 2	Date/Time Test Starting					
10.1.1 3	Date/Time Test Completed	YYYYMMDDHHMMSS	14	14	14	
10.1.1 4	Instrument Identification					

Note 5: Field 10.1.3 “Universal TestID” for ABX Pentra XL80 and Pentra XLR includes the dilution ratio as follows: ^^Result name in english^LOINC code^CDR (CDR=1 or 2 or 3 or 5). Results are returned in between ().

Note 6: Field 10.1.9 “Result Status” for ABX Pentra XL80 and Pentra XLR: if several indicators are required (max. 2) they are separated by “\” delimiter.



2.2.5. Comment record

Table 16: Comment record fields

ASTM field	Definition	Transmitted data	Field max length		
			ABX Pentra 80	ABX Pentra XL80	Pentra XLR
11.1.1	Record Type	C	1	1	1
11.1.2	Sequence Nb	1, 2, ...	2	2	2

Table 16: Comment record fields

ASTM field	Definition	Transmitted data	Field max length		
			ABX Pentra 80	ABX Pentra XL80	Pentra XLR
11.1.3	Comment Source	I clinical instrument system	1	1	1
11.1.4	Comment Text	Text (Refer to Table 23 - Analytical alarms , page 16; Table 24 - Analyzer alarms , page 16; Table 25 - Suspected pathologies , page 17.	100	100	100
11.1.5	Comment Type	G:Free text I: Instrument flag comment L: Comment from host (Patient order) P80 V1.1 and above	1	1	1

2.2.6. Query record (Request information order, for ABX Pentra XL80 and Pentra XLR)

Table 17: Request information record fields

ASTM field	Definition	Transmitted data	Field max length
			ABX Pentra XL80 / Pentra XLR
12.1.1	Record Type	Q	1
12.1.2	Sequence Nb	1	
12.1.3	Identifier	^Sample Id	16
12.1.4	End of identifier list		
12.1.5	Universal Test ID	ALL	3
12.1.6	Time limits		
12.1.7	Time max. limit		

Table 17: Request information record fields

ASTM field	Definition	Transmitted data	Field max length
			ABX Pentra XL80 / Pentra XLR
12.1.8	Time min. limit		
12.1.9	Physician name		
12.1.10	Telephone number		
12.1.11	Reserve for user		
12.1.12	Reserve for user		
12.1.13	Status code	O: Query for test information	1

Instrument request information for one tube at a time: 1 Request information record for each tube.

For example:

```

Instrument
Host
<ENQ>
<ACK>
<STX> 1H|^&|||ABX|||||P|E1394-97|20061124105356<CR><ETX>57<CR><LF>
<ACK>
<STX> 2Q|1|^2312000||ALL|||||O<CR><ETX>72<CR><LF>
<ACK>
<STX> 3L|1|N<CR><ETX>06<CR><LF>
<ACK>
<EOT>
    
```

If Host had no information for the requested tube:

- Instrument receives an empty data frame: Only Header record and Terminator record with “Termination” code set at “I”, the instrument applies a default profile for the tube.
- or
- Instrument applies default profile after a 25 s timeout.

2.2.7. Terminator record

Table 18: Terminator record fields

ASTM field	Definition	Transmitted data	Field max length		
			ABX Pentra 80	ABX Pentra XL80	Pentra XLR
13.1.1	Record type	L	1	1	1
13.1.2	Sequence number	1	1	1	1
		N: Normal I: No information available for last query (ABX Pentra XL80 and Pentra XLR)			
13.1.3	Termination code		1	1	1

3. Special characteristics for HORIBA Medical data

3.1. CBC Data presentation

Table 19: CBC Data presentation

Parameter	Code	Standard	SI	mmol/L	JAPAN
White Blood Cell	WBC	10 ³ /mm ³	10 ⁹ /L	10 ⁹ /L	10 ² /mm ³
Red Blood Cell	RBC	10 ⁶ /mm ³	10 ¹² /L	10 ¹² /L	10 ⁴ /mm ³
Hemoglobin	HGB	g/dL	g/L	mmol/L	g/dL
Hematocrit	HCT	%	L/L	L/L	%
Mean Corpuscular Volume	MCV	µm ³	fL	fL	µm ³
Mean Corpuscular Hemoglobin	MCH	pg	pg	fmol	pg
Mean Corpuscular Hemoglobin Concentration	MCHC	g/dL	g/L	mmol/L	g/dL
Red Distribution Width	RDW	%	%	%	%
Platelets	PLT	10 ³ /mm ³	10 ⁹ /L	10 ⁹ /L	10 ³ /mm ³

Table 19: CBC Data presentation

Parameter	Code	Standard	SI	mmol/L	JAPAN
Mean Platelet Volume	MPV	μm ³	fL	fL	μm ³
Plateletcrit	PCT	%	10 ¹² /L	10 ¹² /L	%
Platelet Distribution Width	PDW	%	%	%	%

3.2. DIFF Data presentation

Table 20: DIFF Data presentation

Parameter	Code	Standard	SI	mmol/L	JAPAN
White Blood Cell	WBC	10 ³ /mm ³	10 ⁹ /L	10 ⁹ /L	10 ² /mm ³
Lymphocytes #	LYM#	10 ³ /mm ³	10 ⁹ /L	10 ⁹ /L	10 ² /mm ³
Lymphocytes %	LYM%	%	%	%	%
Monocytes #	MON#	10 ³ /mm ³	10 ⁹ /L	10 ⁹ /L	10 ² /mm ³
Monocytes %	MON%	%	%	%	%
Granulocytes #	GRA#	10 ³ /mm ³	10 ⁹ /L	10 ⁹ /L	10 ² /mm ³
Granulocytes %	GRA%	%	%	%	%
Neutrophils #	NEU#	10 ³ /mm ³	10 ⁹ /L	10 ⁹ /L	10 ² /mm ³
Neutrophils %	NEU%	%	%	%	%
Eosinophils #	EOS#	10 ³ /mm ³	10 ⁹ /L	10 ⁹ /L	10 ² /mm ³
Eosinophils %	EOS%	%	%	%	%
Basophils #	BAS#	10 ³ /mm ³	10 ⁹ /L	10 ⁹ /L	10 ² /mm ³
Basophils %	BAS%	%	%	%	%
Atypical Lymphocytes #	ALY#	10 ³ /mm ³	10 ⁹ /L	10 ⁹ /L	10 ² /mm ³
Atypical Lymphocytes %	ALY%	%	%	%	%
Large Immature Cell #	LIC#	10 ³ /mm ³	10 ⁹ /L	10 ⁹ /L	10 ² /mm ³
Large Immature Cell %	LIC%	%	%	%	%
Red Blood Cell	RBC	10 ⁶ /mm ³	10 ¹² /L	10 ¹² /L	10 ⁴ /mm ³
Hemoglobin	HGB	g/dL	g/L	mmol/L	g/dL
Hematocrit	HCT	%	L/L	L/L	%
Mean Corpuscular Volume	MCV	μm ³	fL	fL	μm ³

Table 20: DIFF Data presentation

Parameter	Code	Standard	SI	mmol/L	JAPAN
Mean Corpuscular Hemoglobin	MCH	pg	pg	fmol	pg
Mean Corpuscular Hemoglobin Concentration	MCHC	g/dL	g/L	mmol/L	g/dL
Red Distribution Width	RDW	%	%	%	%
Platelets	PLT	10 ³ /mm ³	10 ⁹ /L	10 ⁹ /L	10 ³ /mm ³
Mean Platelet Volume	MPV	μm ³	fL	fL	μm ³
Plateletcrit	PCT	%	10 ¹² /L	10 ¹² /L	%
Platelet Distribution Width	PDW	%	%	%	%

3.3. RET Data presentation (Pentra XLR)

Table 21: RET Data presentation

Parameter	Code	Standard	SI	mmol/L	JAPAN
Reticulocytes %	RET%	%	%	%	%
Reticulocytes #	RET#	10 ⁶ /mm ³	10 ¹² /L	10 ¹² /L	10 ⁴ /mm ³
Corrected Reticulocyte Count	CRC	%	%	%	%
Reticulocytes with a low RNA content	RETL	%	%	%	%
Reticulocytes with a medium RNA content	RETM	%	%	%	%
Reticulocytes with a high RNA content	RETH	%	%	%	%
Mean Reticulocyte Volume	MRV	μm ³	fL	fL	μm ³
Immature Reticulocyte Fraction	IRF	ratio	ratio	ratio	ratio
Reticulocyte Hemoglobin Cellular content	RHCc	pg	pg	fmol	pg

3.4. Manual Input of parameters (ABX Pentra XL80/Pentra XLR)

Table 22: Manual input of parameters Data presentation:

Parameter	English code	Standard	SI	mmol/L	JAPAN
Bands #	BND#	10 ³ /mm ³	10 ⁹ /L	10 ⁹ /L	10 ² /mm ³
Bands %	BND%	%	%	%	%
Metamyelocytes #	MET#	10 ³ /mm ³	10 ⁹ /L	10 ⁹ /L	10 ² /mm ³
Metamyelocytes %	MET%	%	%	%	%
Myelocytes #	MYE#	10 ³ /mm ³	10 ⁹ /L	10 ⁹ /L	10 ² /mm ³
Myelocytes %	MYE%	%	%	%	%
Promyelocytes #	PRO#	10 ³ /mm ³	10 ⁹ /L	10 ⁹ /L	10 ² /mm ³
Promyelocytes %	PRO%	%	%	%	%
Blasts #	BLA#	10 ³ /mm ³	10 ⁹ /L	10 ⁹ /L	10 ² /mm ³
Blasts %	BLA%	%	%	%	%
Others #	OTH#	10 ³ /mm ³	10 ⁹ /L	10 ⁹ /L	10 ² /mm ³
Others %	OTH%	%	%	%	%

3.5. Alarms and Pathologies

ASTM specification reserved no field for pathologies. Pathology messages are sent through the comment record.

Each different type of alarm is transmitted through one different Comment record, a “I” (letter “i” in upper case) flag ended the Comment record and shows a warning from the instrument.

Example:

- H|\^&|||ABX|||||P|E1394-97|20010413105547
- P|1|||SANTOS^JeanPhilippe|||||FRICH Philippe
- .. O|1|0002|7|^^^DIF|||||F
- R|1|^^^WBC^804-5|5.26|10e3/mm3||L|F
- C|1|||^L1^LL^NL^LL1||

3.5.1. Analytical alarms

Analytical alarms are transmitted through one Comment record located after the corresponding Result record.

Table 23: Analytical alarms

Alarm type	ABX Pentra 80 / ABX Pentra XL80 / Pentra XLR
ALARM_WBC	MB, CO, NE, LL, NL, MN, LN, RM, RN, NO, LB, BASO, WBC1, WBC2, Baso+, Baso-, LMNE+, LMNE-, SL1
ALARM_RBC	MI, MA
ALARM_PLT	PC, MC, SC
ALARM_RET (Pentra XLR)	PIT, FIT, NRBC, Balance_Ret+, Balance_Ret-, LOW_COUNT, LASER

3.5.2. Analyzer alarms

Analyzer alarms are transmitted through the Comment record located after the Order record.

Table 24: Analyzer alarms

Alarm type	ABX Pentra XL80 / Pentra XLR	ABX Pentra 80 / ABX Pentra XL80 / Pentra XLR
ALARM_ANALYSER	XB, XR, QC, WESTGARD, STARTUP FAILED, STARTUP NOTDONE, STARTUP NOTEFFECTIVE, FOR INVESTIGATIONAL USE ONLY	MANUAL MATCH, RECALCULATED

3.5.3. Suspected pathologies

Suspected pathologies are transmitted through one Comment record located after corresponding Result record. If several pathologies are suspected they are separated by the component delimiter.

Table 25: Suspected pathologies

Populations	Messages	French	
WBC	Leucocytosis	Leucocytose	
	Leucopenia	Leucopénie	
	Lymphocytosis	Lymphocytose	
	Lymphopenia	Lymphopénie	
	Neutrophilia	Neutrophilie	
	Neutropenia	Neutropénie	
	Eosinophilia	Eosinophilie	
	Myelemia	Myélemie	
	Large Immature Cell	Grandes Cellules Immatures	
	Atypical Lymphocyte	Lymphocytes atypiques	
	Left Shift	Formule Gauche	
	Nrbcs	Erythroblastes	
	Monocytosis	Monocytose	
	Basophilia	Basophilie	
	Blasts	Blastes	
	Pancytopenia	Pancytopénie	
	WBC Interpretation Impossible	Interprétation GB impossible	
	RBC	Anemia	Anémie
		Anisocytosis	Anisocytose degré 1
Microcytes		Microcytes degré 1	
Microcytes+		Microcytes degré 2	
Microcytes++		Microcytes degré 3	
Macrocytes		Macrocytes degré 1	
Microcytosis		Microcytose	
Macrocytosis		Macrocytose	
Hypochromia		Hypochromie degré 1	
Cold Agglutinines		Agglutinine froide	
Pancytopenia		Pancytopénie	
RBC Interpretation Impossible		Interprétation GR impossible	
PLT		Thrombocytosis	Thrombocytose
	Thrombopenia	Thrombopénie	

Table 25: Suspected pathologies

Populations	Messages	French
	Platelet Aggregats	Agrégats plaquettaires
	Small Cells	Petits éléments cellulaires
	Microcytes	Microcytes
	Schizocytes	Schisocytes
	Macroplatelets	Macro plaquettes
	Pancytopenia	Pancytopénie
	PLT Interpretation Impossible	Interprétation Pla impossible
RET (Pentra XLR)	Reticulocytosis	Réticulocytose
	Reticulopenia	Réticulopénie

3.5.4. Suspicion and Reject

When one result is suspected abnormal or false, that means the result is not reliable, the instrument returns a flag in field 10.1.9 (Refer to [Table 15 - Result record fields](#), page 12.).

3.5.5. Normal and Panic ranges

When result exceeds Normal or Panic ranges, flags are transmitted through field 10.1.7; they are compared to the ranges set by the user to get a full result information. These low and high limits can be transmitted through field 10.1.6 (Refer to [Table 15 - Result record fields](#), page 12.).

4. Management of errors

4.1. During Instrument transmission

During a single result transmission by the instrument, if the host lost the transmission (Time-Out or EOT) the full message is transmitted again after a parametrable delay (10 s by default).

In case of long files with several results, the re-transmission is done from the result lost to the end.

After 6 consecutive NAKs detected, the sent file is deferred to later transmission.

4.2. During Host transmission

According to E-1381 protocol, error management of Time-out, Checksum and frame number, in case of non-respect of these norms, return NAK (or communication is halted). In case of transmission of long files (Worklist upload for example), files previously transmitted before transmission error are interpreted and managed by the instrument, others are not used.

According to E-1394 protocol, all Orders without "Sample ID" or with "Sample ID" superiors to 16 characters, are not interpreted by the instrument. (ABX Pentra 80 acknowledges and triggers an alarm on the instrument and the ABX Pentra 80 Host.log is updated).

In case of a "Patient ID" field that is empty or too long, but has a correct "Sample ID", the order is interpreted, but results return with an auto-patient ID set by the instrument. ABX Pentra 80 V1.1 and above reject the Order.

All other too long fields are cut to fit to ASTM field specified length, except for ABX Pentra 80 V1.1 and above: Packet is ignored (A notification is made into the Host.log).

5. Example of data frame

5.1. Example of Order sent by Host

- Patient ID: PID12345
- Patient Name: LASTNAME, FIRSTNAME
- Birthdate: 23/12/1964
- Prescripator: Prescripator
- Department: Location
- Sample ID (mandatory field): SID007
- Test (mandatory field): CBC

Table 26: Example of Order sent by Host

```
Host
Instrument
<ENQ>
<ACK>
<STX>1H|\^&|||ABX|||||P|1394-97|20031202102713<CR><ETX>06<CR><LF>
```

Table 26: Example of Order sent by Host

```
<ACK>
<STX>2P|1||PID12345||LASTNAME^FIRSTNAME||19641223|M|||||Prescripator|||||||Location<CR><ETX>D6<CR><LF>
<ACK>
<STX>3C|1||Patient Comment<CR><ETX>3C<CR><LF>
<ACK>
<STX>4O|1|SID007||^C|R|||||A<CR><ETX>04<CR><LF>
<ACK>
<STX>5C|1||Order Comment<CR><ETX>65<CR><LF>
<ACK>
<STX>6L|1|N<CR><ETX>09<CR><LF>
<ACK>
<EOT>
```

5.2. Example of Result sent by the instrument

Table 27: Example of Result sent by the instrument

```
Instrument
Host
<ENQ>
<ACK>
<STX>1H|\^&|||ABX|||||P|E1394-97|20020725100331<CR><ETX>4D<CR><LF>
<ACK>
<STX>2P|1||AUTO_PID1381||CATHELIN||19260813<CR><ETX>4F<CR><LF>
<ACK>
<STX>3O|1|25028||^D|F|||||||F<CR><ETX>13<CR><LF>
<ACK>
<STX>4R|1|^WBC^804-5|3.45|10e3/mm3||LL||F<CR><ETX>D6<CR><LF>
<ACK>
<STX>5C|1||LEUCOPENIA^LYMPHOPENIA^NEUTROPENIA^EOSINOPHILIA^MONOCYTOSIS||<CR><ETX>C4<CR><LF>
<ACK>
<STX>6R|2|^LYM#^731-0|0.78||LL||F<CR><ETX>DA<CR><LF>
```

Table 27: Example of Result sent by the instrument

```

<ACK>
<STX>7R|3|^^^LYM%^736-9|22.50|%||LL||F<CR><ETX>3B<CR><LF>
<ACK>
<STX>0R|4|^^^MON#^742-7|0.42|%||F<CR><ETX>36<CR><LF>
<ACK>
<STX>1R|5|^^^MON%^744-3|12.20|%||HH||F<CR><ETX>1C<CR><LF>
<ACK>
<STX>2R|6|^^^NEU#^751-8|1.99|%||LL||F<CR><ETX>DE<CR><LF>
<ACK>
<STX>3R|7|^^^NEU%^770-8|57.70|%||F<CR><ETX>A0<CR><LF>
<ACK>
<STX>4R|8|^^^EOS#^711-2|0.26|%||F<CR><ETX>34<CR><LF>
<ACK>
<STX>5R|9|^^^EOS%^713-8|7.40|%||HH||F<CR><ETX>F8<CR><LF>
<ACK>
<STX>6R|10|^^^BAS#^704-7|0.01|%||F<CR><ETX>4E<CR><LF>
<ACK>
<STX>7R|11|^^^BAS%^706-2|0.20|%||F<CR><ETX>75<CR><LF>
<ACK>
<STX>0R|12|^^^ALY#^733-6|0.07|%||F<CR><ETX>61<CR><LF>
<ACK>
<STX>1R|13|^^^ALY%^735-1|1.89|%||F<CR><ETX>92<CR><LF>
<ACK>
<STX>2R|14|^^^LIC#^X-LIC|0.03|%||F<CR><ETX>B0<CR><LF>
<ACK>
<STX>3R|15|^^^LIC%^1117-9|0.80|%||F<CR><ETX>E2<CR><LF>
<ACK>
<STX>4R|16|^^^RBC^789-9|4.43|10e6/mm3||F<CR><ETX>81<CR><LF>
<ACK>
<STX>5R|17|^^^HGB^717-9|13.47|g/dl||F<CR><ETX>D6<CR><LF>
<ACK>
<STX>6R|18|^^^HCT^4544-3|38.95|%||F<CR><ETX>DB<CR><LF>
<ACK>
    
```

Table 27: Example of Result sent by the instrument

```

<STX>7R|19|^^^MCV^787-2|87.94|µm3||F<CR><ETX>EB<CR><LF>
<ACK>
<STX>0R|20|^^^MCH^785-6|30.40|pg||F<CR><ETX>3D<CR><LF>
<ACK>
<STX>1R|21|^^^MCHC^786-4|34.57|g/dl||F<CR><ETX>1C<CR><LF>
<ACK>
<STX>2R|22|^^^RDW^788-0|13.49|%||F<CR><ETX>AB<CR><LF>
<ACK>
<STX>3R|23|^^^PLT^777-3|186.74|10e3/mm3||F<CR><ETX>FA<CR><LF>
<ACK>
<STX>4R|24|^^^MPV^776-5|8.45|µm3||F<CR><ETX>B7<CR><LF>
<ACK>
<STX>5R|25|^^^PCT^X-PCT|0.16|%||F<CR><ETX>D9<CR><LF>
<ACK>
<STX>6R|26|^^^PDW^X-PDW|14.50|%||F<CR><ETX>16<CR><LF>
<ACK>
<STX>7L|1|N<CR><ETX>40<CR><LF>
<ACK>
<EOT>
    
```

ABX Format

ASTM Format is recommended by HORIBA Medical for every new connection development. ABX Format is currently supported to be compliant with earlier instruments or existing connections.

1. Overview

- ABX format supports unidirectionnal or bidirectionnal connections.
- ABX format can have a different number of fields according to the transmitted items set up by the user (results, curves, flags, etc.) or to the type of cycle.
- Fields sequence is not fixed.
- The result identifier is different according to the type of result: patient result ("RESULT"), re-run result (RES-RR), QC result (QC-RES), etc. Refer to [Data transmitted by the host to the analyzer](#) on page 23.

2. Protocol description

2.1. Unidirectionnal mode

2.1.1. Typical unidirectionnal transmission from Instrument to Host

Table 28: Typical unidirectionnal transmission from Instrument to Host

Instrument	<>	Host	Comment
<STX> + RESULT + <ETX>	>		

2.1.2. Typical unidirectionnal transmission from Instrument to Host with "SOH"\ "EOT"

"SOH"\ "EOT" option must be enabled on the instrument.

Table 29: Typical unidirectionnal transmission with "SOH"\ "EOT" from Instrument to Host

Instrument	<>	Host	Comment
<SOH>	>		Instrument takes the Line
<STX> + RESULT + <ETX>	>		
	.		
	.		
<STX> + RESULT + <ETX>	>		
<EOT>	>		Instrument frees the Line

2.2. Bidirectionnal mode

2.2.1. Typical bidirectionnal transmission from Host to Instrument

Table 30: Typical transmission from Host to Instrument:

Instrument	<>	Host	Comment
<SOH>	>		Host takes the Line
	<	<ENQ>	
<STX> + FILE + <ETX>	>		
	<	<ACK>	
	.		
	.		
<STX> + END + <ETX>	>		Host frees the Line
	<	<ACK>	

2.2.2. Typical bidirectionnal transmission from Instrument to Host

Table 31: Typical transmission from Instrument to Host

Instrument	<>	Host	Comment
<SOH>	>		Instrument takes the Line
	<	<ENQ>	
<STX> + RESULT + <ETX>	>		
	<	<ACK>	
	.		
	.		
<STX> + END + <ETX>	>		Instrument frees the Line
	<	<ACK>	

2.3. Conflict management

Number of transmission if negative answer (NAK): 1

Timeout: 15 s

In case of SOH/SOH conflict, priority is given to Host. After an adjustable delay (8 s by default) and if Host has not re-sent a SOH, instrument tries to send SOH again until timeout. This is done until automatic disconnection max time is reached.

3. Message structure

3.1. Lines structure

HEADER:

- STX
- Size + carriage return (Size: 5 bytes representing the total amount of the data except STX and ETX).
- Identifier followed by a Load Type + carriage return (Load: 8 character string preceded by a blank indicating the type of data).

VARIABLE PART:

- Identifier followed by the Information associated to the Load Type + carriage return (Identifier: 1 byte moving about \$21 to \$FF, it describes the information type which follows this indicator, always followed by a blank character \$20).
- Remainder of the other Identifiers and Information associated to the Load Type + carriage returns.
- Other Load Type blocs + Associated Information

POST-HEADER:

- Identifier followed by CheckSum + carriage return (CheckSum: Sum modulo 65536 of all characters except ETX, STX and all information about checksum (identifier - space - checksum - carriage return) in the hexadecimal format on 4 bytes, preceded by a blank character \$20).
- ETX

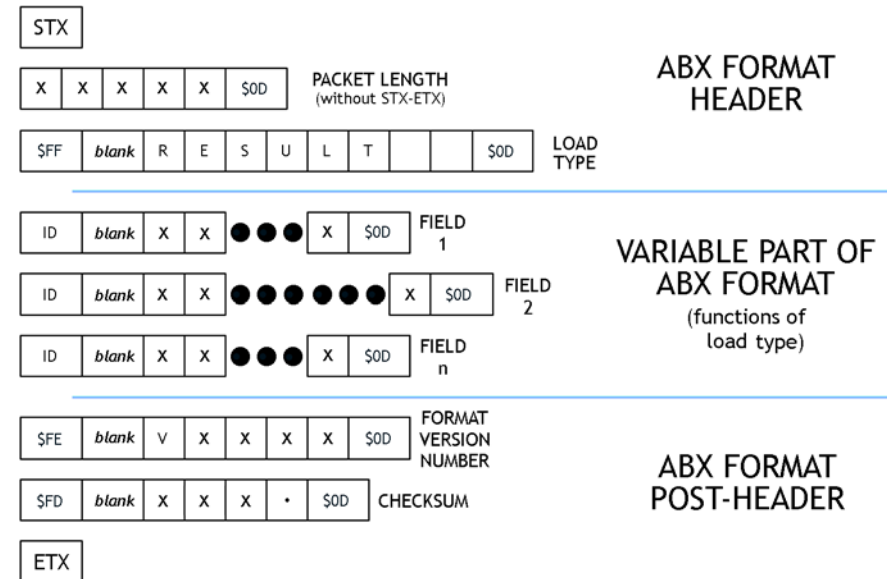

Diag.1: ABX format line structure

3.2. Control characters

Table 32: Standard control characters

Control String	Hexadecimal value
<ENQ>	\$05
<ACK>	\$06
<NAK>	\$15
<STX>	\$02
<ETX>	\$03
<CR>	\$0D
<LF>	\$0A
<EOT>	\$04
<SOH>	\$01

4. Data transmitted by the host to the analyzer

Data packet files are available only if the instrument has been set up with the remote controlled mode.

"FILE" request:

The data packet "FILE" is followed by \$75 or \$76 representing the patient file in order to get the type of test to be run on the corresponding sample.

Table 33: Example of transmission between Host and Instrument:

Flow	Dataflow	Comments
Instrument>Host	\$01	Pentra sends SOH
Host>Instrument	\$05	Host responds ENQ
Instrument>Host	\$02\$FF FILE \$0D \$75 123456789012 \$0D \$03	Pentra sends STX + First Query Message + ETX...
Host>Instrument	\$06	Host responds ACK
Instrument>Host	Pentra sends STX + Next Query Message + ETX
Host>Instrument	\$06	Host responds ACK
Instrument>Host	Pentra sends STX + Last Query Message + ETX
Host>Instrument	\$06	Host responds ACK
Instrument>Host	\$0200043\$0D \$FF END \$0D \$03	Pentra sends STX + Free line + ETX
Host>Instrument	\$06	Host responds ACK

Each data packet "FILE" is preceded and followed by STX and ETX.

Requests of this type can be chained between a line bid and a line free to organize the grouping of requests for instruments equipped with an automatic sampling mode.

Table 34: Data packet strings:

Data packet string	Use
FILE	Patient file
END	Line free message

Patient identification:

- All the described fields have a fixed size character string type and are completed with blanks on the right side for the non-significant information.
- n= number
- c= character

Table 35: Identifier list (Host to Instrument):

Identifier	Correspondance	Example	Length	Format	Transmission	Note
\$70 p	Analyzer number	01	2+2+1	Integers	required	
\$75 u	Id # or sample id.	145030215427 5-42	2+16+1	String(16)	required	
\$76 v	Id. or patient name	SMITH Ronald	2+30+1	String(30)	required	
\$77 w	Birth date	YYYYMMDD	2+8+1	nnnnnn n	optional	8
\$78 x	Age	7d or 4w or 10m or 54y or 100	2+3+1	String(3)	advised	9
\$79 y	Sex	0, 1 or 2	2+1+1	String(1)	advised	10
\$7A z	Origin	x	2+1+1	String(1)	optional	
\$7B {	Doctor	Dr Jones	2+15+1	String(15)	optional	
\$7C	Department	Cardiology	2+10+1	String(10)	optional	
\$7D }	Collection date	06/08/99 13h15	2+14+1	nn/nn/nn nnhhn	optional	11
\$7E ~	Comments		2+32+1	String(32)	optional	
\$7F	Blood type	man	2+16+1	String(16)	optional	12
\$80 ç	Analysis type	A	2+1+1	String(1)	advised	13
\$8B î	Patient identification	200205125751	2+30+1	String(30)	advised	14



Note 7: (ABX Pentra 80 V1.1 and above)

Characters supported goes from \$20 to \$7F for all languages, except for Japanese from \$20 to \$FF. No accent is allowed inside fields.

Note 8: (\$77)

For all instruments: There is no check on \$77 compare to \$78.

For ABX Pentra 80 V1.1 and above: If date is invalid, Birthdate > Date of day, Month or Day incoherent, packet is ignored.



Note 9: (\$78)

\$78 is a 3 characters string completed on the right side by blanks. If age exceeds 99 years, the 3 characters of the string are used for the age without unit (example: 102).

ABX Pentra 80 V1.1 and above: Age is recalculated if Birthdate (\$78) is different.

Note 10: (\$79)

0 or Blank: Unspecified, 1: Male, 2: Female

Note 11: (\$7D)

Only ABX Pentra 80 V1.1 and above: Collection date formats are: YY/MM/DD HHhMM or YYYYMMDD HHhMM. Packet ignored if date or time are incoherent.

Note 12: (\$7F)

\$7F must be one of the instrument blood type list. If not, it is generated according to the age (\$78) or for adults according to the sex (\$79).

Note 13: (\$80)

Test compatibility with the instrument:

'A': CBC

'B': DIF (CBC+DIF)

'C': DIR (DIF+RET)

Note 14: (\$8B)

On ABX Pentra 80 / ABX Pentra XL80 / Pentra XLR the Patient ID field must not be empty otherwise the test is not done.

5. Data transmitted by the analyzer to the host

5.1. Packet type

The information described in the packet type allows the specification of the global message content: hematological routine results or statistic results.

Table 36: Packet type list

Data packet string (8 characters)	Use	Comments
RESULT	Hematological result transmission on a routine mode	
RES-RR	Hematological result transmission on automatic re-sampling mode	
QC-RES-M	Result transmission of a median level control blood	ABX Pentra 80 / ABX Pentra XL80 / Pentra XLR: QC-LVMH transmission
FILE	Patient file request	
END	Connection end	
RES-BLK	Blank cycle results	ABX Pentra 80 Only

5.2. Identifier list (Instrument to Host)

Table 37: Identifier list (Instrument to Host):

Identifier	Correspondance	Example	Length	Format	Note
\$70 p	Analyzer number	01	2+2+1	Integers	
\$71 q	Analysis date and time	03/01/05 13h15mn31s	2+19+1	String(19)	15
\$72 r	Analyzer run number	115 or 005CBC06	2+16+1	String(16)	16
\$73 s	Analyzer sequence number				
\$74 t	Sampling mode	M: manual (open tube) R: rack (close tube)	2+1+1	String(1)	
\$75 u	Id # or sample id.	1450302154275-42	2+16+1	String(16)	

Table 37: Identifier list (Instrument to Host):

Identifier	Correspondance	Example	Length	Format	Note
\$76 v	Id. or patient name	SMITH Ronald	2+30+1	String(30)	
\$77 w	Birth date	16/03/72 or 03161972	2+8+1	nn/nn/nn or nnnnnnnn	17
\$78 x	Age	7d or 4w or 10m or 54y or 100	2+3+1	String(3)	
\$79 y	Sex	0, 1 or 2	2+1+1	String(1)	10
\$7A z	Origin	x	2+1+1	String(1)	
\$7B {	Doctor	Dr Jones	2+15+1	String(15)	
\$7C	Department	Cardiology	2+10+1	String(10)	
\$7D }	Collection date	06/08/99 13h15	2+14+1	nn/nn/nn nnhhnn	11
\$7E ~	Comments		2+32+1	String(32)	
\$7F	Blood type	man	2+16+1	String(16)	12
\$80 ç	Analysis type	A	2+1+1	String(1)	13
\$81 ü	Sample rack type	0: 10 positions 1: 15 positions 2: 32 positions	2+1+1	Integer	
\$82 é	Number of runs	0, 1, ...	2+1+1	Integer	
\$83 â	Operator code	Bob	2+3+1	String(3)	

Note 15: (\$71)

ABX Pentra 80 V1.1 and above: Valid date format is YY/MM/DD
HHhMMmSSs

Note 16: (\$72)

ABX Pentra XL80 / Pentra XLR: Information about the rack number, the type of test and the tube position.

Rack number: From 001 to 999

Test: CBC or DIF

Tube position: From 01 to 10

Note 17: (\$77)

ABX Pentra 80 V1.1 and above: Valid date format is YY/MM/DD



5.2.1. Numerical result fields

- Units are standard units.

- If one parameter cannot be calculated by the analyzer, the field is replaced by ---.

Parameter status:

Following the numerical field, a first digit gives the counting rejection status or the suspicion, a second one gives the parameter value status according to high and low normalities, to high and low extreme values and to the overloading capacities.

Table 38: Identifier First digit

First digit (letter)	Correspondance	Comments
R	Parameter rejected for a counting default	
B	Incorrect balance between the counting methods	ABX Pentra 80: Not transmitted
S	Suspicious parameter value	
M	Value input manually	ABX Pentra XL80 / Pentra XLR
D	Value obtained by dilution	ABX Pentra XL80 / Pentra XLR
blank	No anomaly observed	

Table 39: Identifier Second digit

Second digit (letter)	Correspondance	Comments
L	Parameter < to the lower extreme value	
I	Parameter < to the low normal value	
blank	Parameter normal value	
h	Parameter > to the high normal value	
H	Parameter > to the high extreme value	
C	Platelet concentrate	ABX Pentra 80 V1.1 and above
O	Parameter exceeding the capacity	

Example: 5.5 millions RBC with a counting error in the standard units:

\$32 \$20 \$30 \$35 \$2E \$35 \$30 \$52 \$68 \$0D or

"2 05.50Rh" + carriage return.

Table 40: ABX Pentra XL80 / Pentra XLR Identifier Third digit

Third digit (letter)	Correspondance
D	Parameter obtained by dilution ratio other than 1
blank	Parameter normal value

Table 41: ABX Pentra XL80 / Pentra XLR Identifier Fourth digit

Fourth digit (letter)	Correspondance
blank	For further use

Table 42: ABX Pentra XL80 / Pentra XLR Identifier Fifth digit

Fifth digit (letter)	Correspondance
blank	For further use

Example for ABX Pentra XL80 / Pentra XLR: 5.5 millions RBC with a counting error in the standard units:

\$32 \$20 \$30 \$35 \$2E \$35 \$30 \$52 \$68 \$44 \$20 \$20 \$0D or
 "2 05.50RhD" + carriage return.

Table 43: CBC numerical result fields list

Identifier	Correspondance	Example	ABX Pentra 80 Format (Length)	ABX Pentra XL80 / Pentra XLR Format (Length)
\$21 !	WBC	07.40	2+String(7)+1	2+String(10)+1
\$32 2	RBC	04.64	2+String(7)+1	2+String(10)+1
\$33 3	Hgb	14.17	2+String(7)+1	2+String(10)+1
\$34 4	Hct	43.95	2+String(7)+1	2+String(10)+1
\$35 5	MCV	94.68	2+String(7)+1	2+String(10)+1
\$36 6	MCH	30.53	2+String(7)+1	2+String(10)+1
\$37 7	MCHC	32.24	2+String(7)+1	2+String(10)+1
\$38 8	RDW	12.98	2+String(7)+1	2+String(10)+1
\$40 @	PLT	00401	2+String(7)+1	2+String(10)+1

Table 43: CBC numerical result fields list

Identifier	Correspondance	Example	ABX Pentra 80 Format (Length)	ABX Pentra XL80 / Pentra XLR Format (Length)
\$41 A	MPV	07.94	2+String(7)+1	2+String(10)+1
\$42 B	THT	0.318	2+String(7)+1	2+String(10)+1
\$43 C	PDW	13.50	2+String(7)+1	2+String(10)+1

Table 44: DIFF numerical result fields list

Identifier	Correspondance	Example	ABX Pentra 80 Format (Length)	ABX Pentra XL80 / Pentra XLR Format (Length)
\$21 !	WBC	07.40	2+String(7)+1	2+String(10)+1
\$22 "	Lymphocytes (#)	02.03	2+String(7)+1	2+String(10)+1
\$23 #	Lymphocytes (%)	27.40	2+String(7)+1	2+String(10)+1
\$24 \$	Monocytes (#)	00.70	2+String(7)+1	2+String(10)+1
\$25 %	Monocytes (%)	09.40	2+String(7)+1	2+String(10)+1
\$28 (Neutrophils (#)	04.51	2+String(7)+1	2+String(10)+1
\$29)	Neutrophils (%)	60.90	2+String(7)+1	2+String(10)+1
\$2A *	Eosinophils (#)	00.13	2+String(7)+1	2+String(10)+1
\$2B +	Eosinophils (%)	01.70	2+String(7)+1	2+String(10)+1
\$2C ,	Basophils (#)	00.04	2+String(7)+1	2+String(10)+1
\$2D -	Basophils (%)	00.60	2+String(7)+1	2+String(10)+1
\$2E .	Atypical Lymphocytes (#)	00.11	2+String(7)+1	2+String(10)+1
\$2F /	Atypical Lymphocytes (%)	01.49	2+String(7)+1	2+String(10)+1
\$30 0	Large Immature Cells (#)	00.03	2+String(7)+1	2+String(10)+1
\$31 1	Large Immature Cells (%)	00.43	2+String(7)+1	2+String(10)+1
\$32 2	RBC	04.64	2+String(7)+1	2+String(10)+1
\$33 3	Hgb	14.17	2+String(7)+1	2+String(10)+1
\$34 4	Hct	43.95	2+String(7)+1	2+String(10)+1
\$35 5	MCV	94.68	2+String(7)+1	2+String(10)+1
\$36 6	MCH	30.53	2+String(7)+1	2+String(10)+1
\$37 7	MCHC	32.24	2+String(7)+1	2+String(10)+1
\$38 8	RDW	12.98	2+String(7)+1	2+String(10)+1

Table 44: DIFF numerical result fields list

Identifier	Correspondance	Example	ABX Pentra 80 Format (Length)	ABX Pentra XL80 / Pentra XLR Format (Length)
\$40 @	PLT	00401	2+String(7)+1	2+String(10)+1
\$41 A	MPV	07.94	2+String(7)+1	2+String(10)+1
\$42 B	THT	0.318	2+String(7)+1	2+String(10)+1
\$43 C	PDW	13.50	2+String(7)+1	2+String(10)+1

Table 45: RET numerical result fields list (Pentra XLR only)

Identifier	Correspondance	Example	ABX Pentra 80 Format (Length)	ABX Pentra XL80 / Pentra XLR Format (Length)
\$32 2	RBC	04.64	2+String(10)+1	
\$3B ;	Reticulocytes (#)	0656	2+String(10)+1	
\$3C <	Reticulocytes (%)	01.41	2+String(10)+1	
\$3D =	RETL	885.4	2+String(10)+1	
\$3E >	RETM	126.8	2+String(10)+1	
\$3F ?	RETH	100.0	2+String(10)+1	
\$44 D	PIC	56920	2+String(10)+1	
\$48 H	MFI	206.0	2+String(10)+1	
\$49 I	Mean reticulocyte vol.	107.5	2+String(10)+1	
\$4A J	Corrected ret. count	01.38	2+String(10)+1	
\$4C L	IRF	0.500	2+String(10)+1	
\$4D	RHCc	025.7	2+String(10)+1	

Table 46: Manual input fields list:

Identifier	Correspondance	Example	ABX Pentra 80 Format (Length)	ABX Pentra XL80 / Pentra XLR Format (Length)
\$D0	Bands (#)		2+String(7)+1	2+String(10)+1
\$D1	Bands (%)		2+String(7)+1	2+String(10)+1
\$D2	Metamyelocyte (#)		2+String(7)+1	2+String(10)+1

Table 46: Manual input fields list:

Identifier	Correspondance	Example	ABX Pentra 80 Format (Length)	ABX Pentra XL80 / Pentra XLR Format (Length)
\$D3	Metamyelocyte (%)		2+String(7)+1	2+String(10)+1
\$D4	Myelocyte (#)		2+String(7)+1	2+String(10)+1
\$D5	Myelocyte (%)		2+String(7)+1	2+String(10)+1
\$D6	Promyelocyte (#)		2+String(7)+1	2+String(10)+1
\$D7	Promyelocyte (%)		2+String(7)+1	2+String(10)+1
\$D8	Blasts (#)		2+String(7)+1	2+String(10)+1
\$D9	Blasts (%)		2+String(7)+1	2+String(10)+1
\$DA	Others (#)		2+String(7)+1	2+String(10)+1
\$DB	Others (%)		2+String(7)+1	2+String(10)+1

Table 47: ABX Pentra XL80 / Pentra XLR Dilution ratio management:

Identifier	Correspondance	Example	Format (Length)
\$A4	WBC Parameters	1	2+String(1)+1
\$A5	RBC Parameters	1	2+String(1)+1
\$A6	PLT Parameters	1	2+String(1)+1
\$A7	DIFF Parameters (same as WBC)	1	2+String(1)+1

- 1: normal dilution ratio
- 2: one half dilution ratio
- 3: one third dilution ratio
- 5: one fifth dilution ratio

5.2.2. Flag fields

Flags are transmitted in a comprehensive mode (same presentation than on the screen, that is to say dependant from the language). They are replaced with blanks when the flag is not detected.



In the following tables, identifier's formats are separated by a white space only for a better comprehension.

Table 50: Pathological format description

Population	Message	Meaning
	CAGG	Cold agglutinin
	ERYT	Erythrocytosis
Plt	THR+	Thrombocytosis
	THR-	Thrombopenia
	PLAG	Platelet aggregates
	SCEL	Small cells
	MICC	Microcytes
	SCHI	Schizocytes
	MAPL	Macro platelet
Reticulocytes	RET+ or RET- (Pentra XLR only)	Reticulocytosis Reticulopenia (refer to Note 18 , page 29.)
All populations	????	No interpretation
	PANC	Pancytopenia



Note 18: (RET+ and RET-)
These pathological formats only apply to Pentra XLR.

5.2.4. Histograms

5.2.4.1. Overview

Histograms are transmitted on 128 channels, preceded by a blank. They are automatically rescaled to a 223 maximum amplitude value. The zero amplitude value is \$20, the maximum amplitude value is \$FF.

Extended format:

The extended format includes all the height information relative to each channel. It is constituted by a chart of 256 [RES] entries of 16 bits each.

These 512bytes chart is encoded before being transmitted. The format is as follows: identifier, space, encoding type on 8 characters (od or uuencode), space, encoded data size on 5 characters, space, data then carriage return.

5.2.4.2. Separation thresholds

It is the channel number (decimal value) enclosing areas on the histograms or on the matrix. Each threshold is transmitted on 3 bytes preceded by a blank. Format description of the threshold transmission

A. WBC thresholds

Separation thresholds 1-2-3 allow the L1 flag determination. For the analyzers in LMG mode, the 4-5 thresholds allow the separation of the 3 populations Lymphocytes, Monocytes, Granulocytes.

Example 1: output format of the WBC curve thresholds for an LMG sampling. In this example, the analyzer does not send the calculation thresholds of the L1 flag.

«] 000 000 000 040 060» + carriage return

Example 2: output format of the WBC curve thresholds for CBC and DIFF sampling. In this 5parts DIFF analyzer, the LMG is not measured, the 4-5 thresholds are not significant.

«] 005 008 020 000 000» + carriage return.

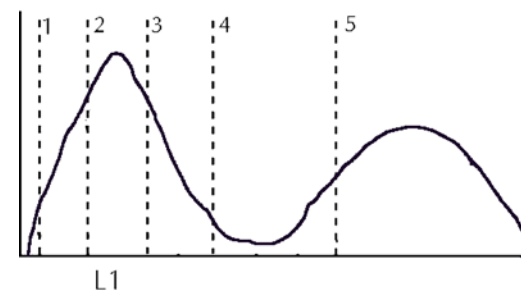

Diag.2: WBC histogram

B. RBC thresholds

Separation thresholds 1-2 allow the calculation of the microcytic and macrocytic cell proportions.

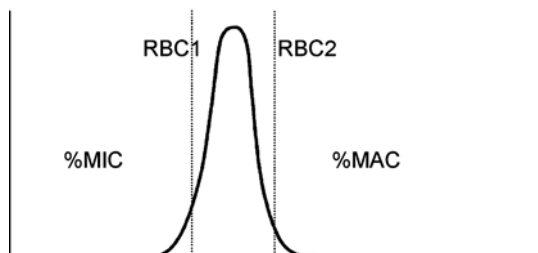

Diag.3: RBC histogram

C. PLT thresholds

The threshold 1 is the number of the last channel used to calculate the number of PLT.



Diag.4: PLT histogram

D. Basophil thresholds

Thresholds 1-2-3 allow the determination of the basophil proportion regarding the total number of WBC.

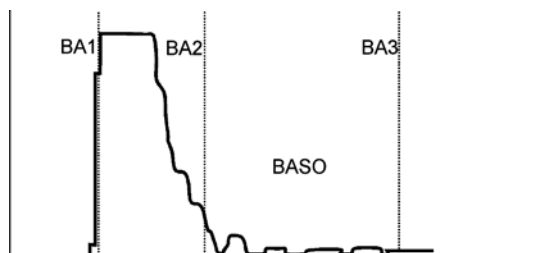

Diag.5: BASO histogram

Table 51: Histograms format description

Identifier	Parameter	Format	Length
\$57 W	WBC	Amplitude of each channel	2+128+1
\$58 X	RBC	Amplitude of each channel	2+128+1
\$59 Y	Plt	Amplitude of each channel	2+128+1
\$5A Z	Basophils	Amplitude of each channel	2+128+1
\$5B [LMNE matrix	Screen bitmap	2+4096+1
\$5C \	RET matrix	Screen bitmap	2+4096+1
\$5D]	WBC thresholds	5 thresholds	1+20+1
\$5E ^	RBC thresholds	2 thresholds	1+8+1
\$5F _	PLT thresholds	1 threshold	1+4+1
\$60 '	Basophil thresholds	3 thresholds	1+12+1
\$61 a	LMNE matrix thresholds	12 RES thresholds, 6 ABS thresholds	1+72+1
\$62 b	RET matrix thresholds	4 CIS thresholds, 4 OFL thresholds	1+32+1
\$6C l	WBC	extended format	see description
\$6D m	RBC	extended format	see description
\$6E n	PLT	extended format	see description
\$6F o	BASO	extended format	see description

5.2.5. Matrix

A. Screen bitmap

2048 graphic bytes matrix are transmitted on 4096 ASCII bytes, preceded by a blank. Each group of 2 ASCII bytes is the value of 1 graphic byte represented from the left to the right and from the top to the bottom of the screen. The double matrix [127 (ABS) x 256 (RES)] is transmitted according to the same procedure.

Extended mode format (3D curve): The extended format includes all the height information relative to each channel. It is constituted by a chart of 128 [ABS] x 128 [RES], 128 [ABS] x 256 [RES] or 256 [OFL] x 128. Extended mode format (3D curve): The extended format includes all the height information relative to [CIS] entries of 16 bytes each. These 32K or 64K charts are first of all compressed (3k approximately for a 32K chart) then encoded (expansion 1 to 2) before being transmitted. The format is as follows: identifier, space, compression algorithm on 8 characters ("compress" or "gzip" or "lha" or "squeeze"), space, encoding type on 8 characters (od or uuencode),

chart format on 8 characters, space, encoded data size on 5 characters, space, data then carriage return.

Examples:

\$6C \$20 uuencode \$20 00724 \$20 data \$0D
 \$64 \$20 lha\$20\$20\$20\$20\$20 \$20od\$20\$20\$20\$20\$20\$20 \$20 128Y256X \$20 10772
 \$20 data \$0D
 \$65 \$20 compress \$20 uuencode \$20128X128Y \$20 05386 \$20 data \$0D

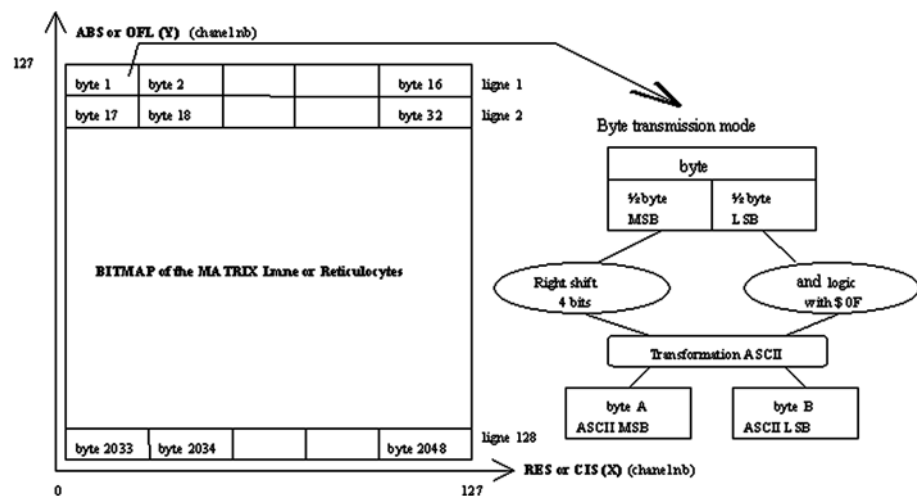

Diag.6: Matrix transmission

B. LMNE matrix thresholds

The 12 resistive thresholds are transmitted in the following order: NoL, NoN, NoE, LN, RN, LL, AL, LMU, LMD, LMN, MN, RM.

Resistive threshold “Channel 127” is set on channel 127 of the matrix and is not movable (As it is not movable, “Channel 127” is not transmitted by the instrument).

The 3 absorbance thresholds are following: NL, NE, RMN.

At the end, the width of the areas (in channel number) describing the proximity flags: FNE, FMN, FLN are transmitted.

Areas surrounded by bolt lines give the matrix populations. Population names are italicized.

Hatched areas give the sub-populations and belong to the main population.

Framed items are the proximity flags. Surrounded items are inflexion points similar to separation thresholds.

Table 52: Channel Numbers for Resistive Thresholds

Thresholds	Channel numbers
NoL	024
NoN	027
NoE	050
LN	035
RN	118
LL	031
AL	069
LMU	073
LMD	100
LMN	069
MN	100
RM	118

Table 53: Channel Numbers for Absorbance Thresholds

Thresholds	Channel numbers
NL	029
NE	077
RMN	051

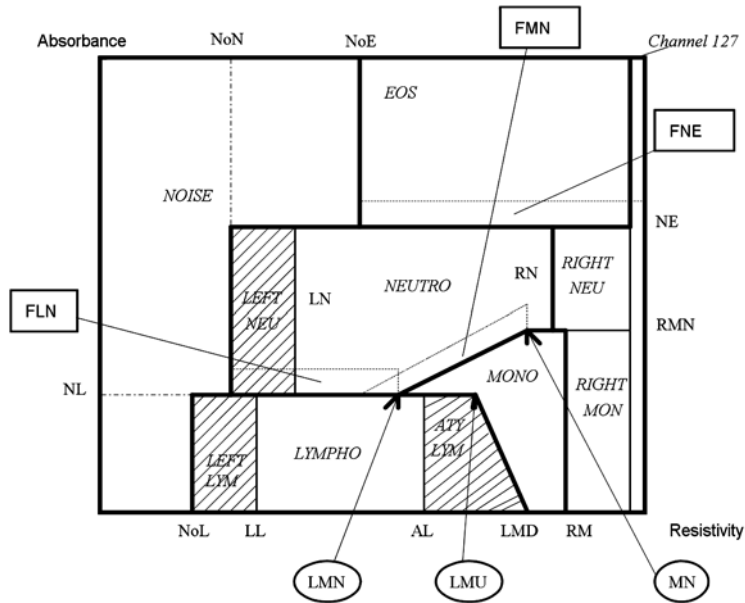

Diag.7: LMNE matrix thresholds

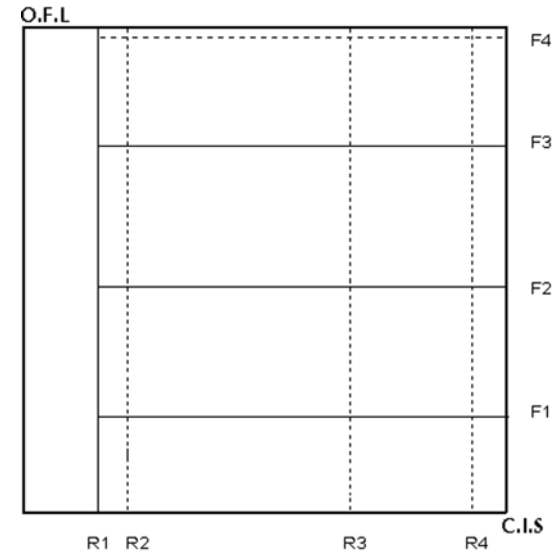

Diag.8: RET matrix identifier

C. Reticulocyte matrix identifier

The 4 resistive thresholds are transmitted in the following order: R1, R2, R3, R4. Then the 4 fluorescent thresholds are following: F1, F2, F3, F4.

Table 54: Matrix format description

Identifier	Parameter	Format	Length	Note
\$5B [LMNE matrix	Screen bitmap	2+4096+1	
\$61 a	LMNE matrix thresholds	12 RES thresholds, 6 ABS thresholds (3 of them give the proximity flags: FLN, FMN, FNE)	1+72+1	
\$62b	Reticulocyte matrix thresholds	4 CIS thresholds, 4 OFL thresholds	1+32+1	19
\$64 d	LMNE matrix	extended format	see description	
\$65e	Reticulocyte matrix	extended format	see description	19



Note 19: (\$62b and \$65e)
These parameters only apply to Pentra XLR.

5.2.6. Other identifiers

Identifier \$FB: Identifies the analyzer type when communicating.
 Identifier \$FC: This identifier allows the transmission of a number which can be an error number, a position number, a burn-in sequence number or a status in hexadecimal mode (Not available yet).
 Identifier \$FD: Checksum value (see section on the message structure).
 Identifier \$FE: The version number is linked to the development of the hematological message identifiers.



Identifier \$FC: The error list is dedicated to the "remote" mode.
 For \$FB and \$FF, the strings having less than 8 characters are completed on the right side by blanks.

Table 55: Other identifiers

Identifier	Correspondance	Format	Length
\$A3	ABX Pentra XL80 / Pentra XLR: Report state	V: Validated R: Rejected U: Unvalidated	2+1+1
\$FB	Analyzer name	Character string	2+8+1
\$FC	Number	8 decimal bytes	2+8+1
\$FD	16 bits check sum value	4 hexadecimal bytes	2+4+1
\$FE	Version N° of Identifier list	Character string Vx.xx	2+5+1

6. Query mode

Requests sent by the Host when the line is free.

- This optional mode allows the Host to selectively load the working list of each sample, once the barcode of the sample has been read and a Query request is emitted by the instruments.
- This mode is of particular interest when the Host system manages several instruments analysers. In this case, the Query request transmitted by one of the analysers allows the Host system to load the working list on the instrument identified by the presence of the sample on this analyzer.
- The Query request is a 'FILE' type message and encapsulates 1 or several blocks surrounded by STX & ETX including the '\$75' type line followed by the identification of the sample (barcodes) (Maximum 10 Blocks per Query request).
- Transmission of the Query requests is carried out by instrument immediately after the tray of 10 samples has been read. Only the samples identified by a barcode, and for which instrument did not receive a working list are transmitted in the QUERY request.
- The Host system has an answering delay which is adjustable on the analyzer (25 seconds by default). This delay is fixed after transmission of the last Query message, in order to return the message to load the working list of the sample or the samples concerned. Once the delay has been respected and in the case where no message is received by the analyzer, the rack of samples is automatically discharged without carrying out tests.
- The adjustment of the answering delay of the Host system is ideally fixed at 25 seconds by default. It is possible to change the value of this parameter, however, from 30 seconds on the analyser generates a supplementary waiting cycle of 30 seconds, or 2 waiting cycles from 60 seconds, involving a reduction of the analytical output capacity.

Table 56: QUERY request line structure

Identifier	Correspondance	Format	Length
\$FF y	Data Packet	Character string	2+8+1
\$75 u	Identification #	Character string	2+16+1

Loading protocol of a working list in answer to a QUERY request:

Table 57: Instrument transmits to the Host a QUERY request

Flox	Dataflow	Comments
Instrument>Host	\$01	Analyzer sends SOH
Host>Instrument	\$05	Host responds ENQ
Instrument>Host	\$02\$FF FILE \$OD \$75 123456789012 \$OD \$03	Analyzer sends STX + First Query Message + ETX
Host>Instrument	\$06	Host responds ACK
Instrument>Host	Analyzer sends STX + Next Query Message + ETX
Host>Instrument	\$06	Host responds ACK
Instrument>Host	Analyzer sends STX + Last Query Message + ETX
Host>Instrument	\$06	Host responds ACK
Instrument>Host	\$02 00043\$OD \$FF END \$OD \$03	Analyzer sends STX + Free line + ETX
Host>Instrument	\$06	Host responds ACK

Once the Host receives a Query type message, it returns a message to load the working list for the sample or samples concerned, respecting the delay programmed on the analyzer (25 seconds by default).