 **ABX Diagnostics** Montpellier

ABX Diagnostics

Output format for haematology analyzers

Pentra 60/Pentra 60C+/Pentra 80/Pentra 80 XL/Pentra 120
Micros/Micros 60/Micros CRP

P/N: RAA024GA



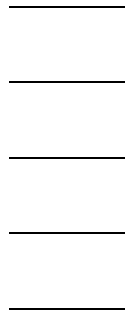

Chapter 1

Introduction

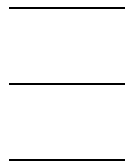



Introduction

Index of chapters

- RS232 connection
- ASTM Format
- ABX Format
- ARGOS Format

Introduction

ASTM Format is recommended by ABX Diagnostics for every new connection development. ABX Format, is currently supported to be compliant with existing connections, but will not be supported on future generation of instrument. Argos Format is not supported on new system generation.

Different protocols can be used on ABX Diagnostics instrument, a connection between a computer (host) and an ABX diagnostics instrument can be performed when the protocol, the format description and the connection mode have been properly setup.

1. Micros family

Table 1: Format compatibility according to ABX analyzers and types of analyses (Micros)

ABX Analyzers	Micros			Micros 60			Micros CRP		
	ABX	ASTM	Argos	ABX	ASTM	Argos	ABX	ASTM	Argos
Analysis type									
LMG (CBC+LMG)	X		X	X		X	X		X
CRP							X		X
Output Formats:	ABX	ASTM	Argos	ABX	ASTM	Argos	ABX	ASTM	Argos

2. Pentra family\RS232 Physical connection

Table 2: Format compatibility according to ABX analyzers and types of analyses (Pentra)

ABX Analyzers	Pentra 60			Pentra 60C+			Pentra 80\XL80			Pentra 120											
	Analysis type	ABX	ASTM	Argos	ABX	ASTM	Argos	ABX	ASTM	Argos	120			120RET			120SPS			120RETSPS	
ABX											ASTM	Argos	ABX	ASTM	Argos	ABX	ASTM	Argos	ABX	ASTM	Argos
Receive Orders				X	X	X	X	X		X		X	X		X	X		X	X		X
TSO mode				X	X		X	X		X			X			X			X		
Query							X (XL80)	X (XL80)		X		X	X		X	X		X	X		X
Re-sampling										X		X	X		X	X		X	X		X
CBC	X		X	X	X	X	X	X		X		X	X		X	X		X	X		X
DIF (CBC+DIF)	X		X	X	X	X	X	X		X		X	X		X	X		X	X		X
RET													X		X				X		X
CBR (CBC+RET)													X		X				X		X
DIR (CBC+DIF+RET)													X		X				X		X
SPS																X		X	X		X
Output Formats:	ABX	ASTM	Argos	ABX	ASTM	Argos	ABX	ASTM	Argos	ABX	ASTM	Argos	ABX	ASTM	Argos	ABX	ASTM	Argos	ABX	ASTM	Argos

3. Pentra family\Ethernet Physical connection

3.1. UDP\TCP Mode

Table 3: Format compatibility according to ABX analyzers and types of analyses (Pentra)

ABX Analyzers	PentraXL 80
Analysis type	ASTM
Receive Orders	X
TSO mode	X
Query	X
CBC	X
DIF (CBC+DIF)	X
Output Format:	ASTM

3.2. FTP Mode

Table 4: Format compatibility according to ABX analyzers and types of analyses (Pentra)

ABX Analyzers	PentraXL 80
Analysis type	ASTM
CBC	X
DIF (CBC+DIF)	X
Output Format:	ASTM

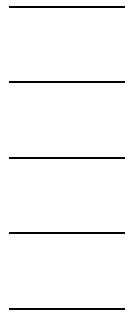

Chapter 2

Physical Connection

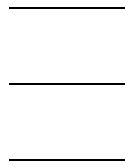



RS232 connection

1. Instruments RS Port connectors

Table 5: Instruments RS port connector

RS Connector	Micros	Pentra 60/60C+	Pentra 80/XL80	Pentra 120
DB9 (male)	X	X	X	
DB25 (male)				X

2. Instrument RS DB9

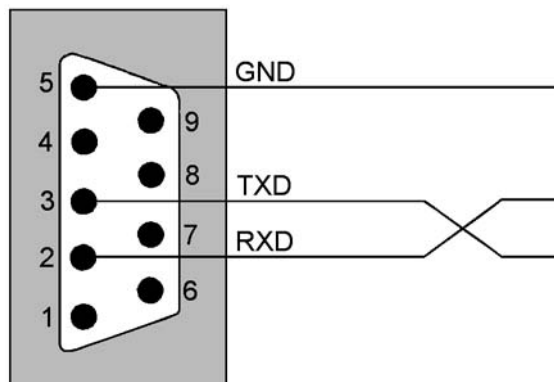

3. Instrument DB25

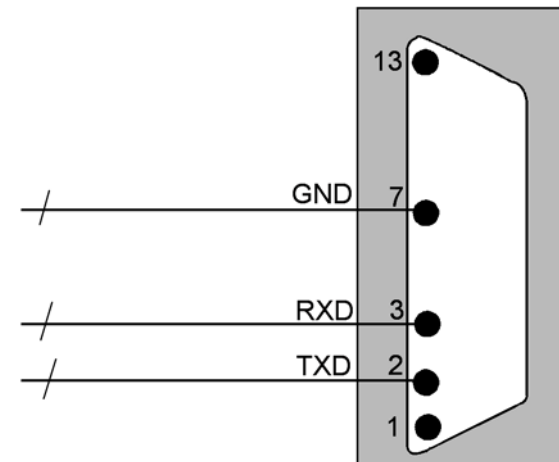



Ethernet connection (PentraXL 80 in ASTM mode Only)

You can access and setup ethernet parameters by entering PentraXL 80 menu: «Settings\System\Communication». If «Network settings» tab is not available on screen make sure ASTM mode is selected in «General» tab.

1. FTP Mode

The instrument start connection with FTP server just before it sends the file, then it is disconnected. Every file sent execute one connection, the same named file must not be on the server when the instrument tries to transfer the file, the Host has to manage the previous sent file.

The files are sent under name «RESXXXXX.AST».
«RESXXXXX.AST» is incremented from 00000 to 99999.
Each line of file «RESXXXXX.AST» is a «Record» according to ASTM format.
A «Record» had no checksum.

2. UDP Mode

Host UDP socket must be setup with:

- Instrument IP address or DNS address
- The Port number where Instrument is awaiting connection

Instrument UDP socket must be setup with:

- Host IP address or DNS address
- The Port number where Host is awaiting connection (Same one used to await connection)

The data format is according to ASTM protocol.

3. TCP Mode

Host TCP socket must be setup with (Host is always server):

- Port number where Instrument will be connected

Instrument TCP socket must be setup with (Instrument is always client):

- Host IP address or DNS address
- the Port number where Host is awaiting connection

The data format is according to ASTM protocol.

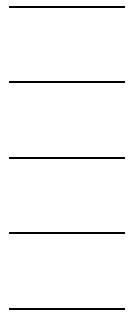

Chapter 3 ASTM Format

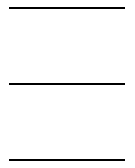



ASTM Format

ABX Diagnostics analyzers format responds to the ASTM specifications E-1381 & E-1394:

- E-1381: Standard specification for Low Level protocol to transfer messages between clinical and laboratory instruments and computer systems.
- E-1394: Standard specification for transferring Information between clinical and laboratory instruments and computer systems.

1. Connection specifications (ASTM E-1381)

1.1. Hardware and software characteristics

Default format for emitted character is 1 bit start, 8 data bits, No parity, 1 bit stop.
 Default communication speed is 38400 bauds.

Hardware setting of the interface: Plug A&B are DB9 male plugs.

1.2. Output data characteristics

Characters: ASCII
 Maximum message length: 247 characters.
 Analyzer manages Xon/Xoff protocol.

1.3. Communication protocol

Table 6: Standard control characters

Control String	Hexadecimal value
<ENQ>	\$05
<ACK>	\$06
<NAK>	\$15
<STX>	\$02
<ETX>	\$03
<CR>	\$0D
<LF>	\$0A
<EOT>	\$04

1.3.1. Instrument\Host connexion

Table 7: Typical discussion between Instrument and Host

Instrument	<>	Host
<ENQ>	>	
	<	<ACK>
<STX>1...Data...<CR><ETX>xx<CR><LF>	>	
	<	<ACK>
<STX>2...Data...<CR><ETX>xx<CR><LF>	>	
	<	<ACK>
<EOT>	>	



Table 8: Typical discussion between Host and Instrument

Instrument	< >	Host
	<	<ENQ>
<ACK>	>	
	<	<STX>1...Data...<CR><ETX>xx<CR><LF>
<ACK>	>	
	<	<STX>2...Data...<CR><ETX>xx<CR><LF>
<ACK>	>	
	<	<EOT>

1.3.2. Discussion with conflict between Instrument and Host

Number of transmission if negative answer (NACK): 6
 Timeout if no response: 15s (Automatic disconnection max. time)
 Retry timeout: Variable < 30s
 Special timing: None
 Description of other specific treatments: None

In case of ENQ\ENQ conflict analyzer waits 2s and tries emission again.

Analyzer is master in case of conflict.

Table 9: Discussion with conflict between Instrument and Host

Instrument	< >	Host
<ENQ>	>	
	<	<ENQ>
Wait 2 second...		
<ENQ>	>	
	<	<ACK>

Table 9: Discussion with conflict between Instrument and Host

Instrument	< >	Host
<STX>1...Data...<CR><ETX>xx<CR><LF>	>	
	<	<ACK>
<STX>2...Data...<CR><ETX>xx<CR><LF>	>	
	<	<ACK>
<EOT>	>	

1.3.3. Defect packet during discussion between Instrument and Host

Table 10: Defect packet during discussion between Instrument and Host

Instrument	< >	Host
<ENQ>	>	
	<	<ACK>
<STX>1...Data...<CR><ETX>xx<CR><LF>	>	
	<	<NAK>
<STX>1...Data...<CR><ETX>xx<CR><LF>	>	
	<	<ACK>
<STX>2...Data...<CR><ETX>xx<CR><LF>	>	
	<	<ACK>
<EOT>	>	

1.4. ASTM Data frame format

A sequential number located after the <STX> charcater is inserted into each Data frame. Frame number is set to 1 when transfer phase is initialized and is incremented by 1 for each frame up to 7 and then returns to 0. Frame number is to permit receiver to distinguish between new and retransmitted frame,



in case of retransmitted frame (after a <NAK> response from Host), frame number is not incremented: <STX>1...Data...<CR><ETX>xx<CR><LF>

Table 11: Frame format

ASTM field	Definition	Transmitted data	# of bytes	Comments
0	STX	\$02	1	
1	Frame number	1 to 7, 0, ...	1	Frame number is set to 1 and incremented by 1 for each frame up to 7 and then returns to 0
2	Data message		240 max.	Header, Patient, Order, Result & Comment messages
3	End of data message ETX if end frame		1	
4	Checksum		2	
5	CRLF	\$0D \$0A	2	

1.4.1. Frame checksum

According to ASTM E-1381 frame checksum (<STX>1...Data...<CR><ETX>xx<CR><LF>) is defined as modulo 256 of ASCII values sum between <STX> not included and <ETX> included characters: 1...Data...<CR><ETX>

2. Records general format specifications (ASTM 1394)

Data frames encapsulate Records defined by ASTM E-1394 norm, Records themselves encapsulate ATSM fields.

Example of record inside Data frame: <STX>1...Data...<CR><ETX>xx<CR><LF>

<STX>1H|^&||||HostSimulator||||ABX||P|E1394-97|20020705144108<CR><ETX>D3<CR><LF>

Table 12: ASTM Records

Record ID	ASTM Definition	P60C+	P80	PXL 80
H	Header	X	X	X
P	Patient	X	X	X
O	Order	X	X	X
R	Result	X	X	X
C	Comment	X	X	X
Q	Query (Request information order)			X
S	Scientific Record			
M	Manufacturer informations			
L	Terminator record	X	X	X

2.1. Structure of Records

2.1.1. Structure of records for Order transmission

- H (Header)
- ..P (Patient)
- ..C (Patient Comments) Optional
-O (Order)
-C (Order Comments) Optional
- L (Terminator)

The transmission of an Order without Patient record is not allowed, but Patient record can be empty. Example: <STX>2P|1<CR><ETX>BB<CR><LF>

2.1.2. Instrument Patient file modification by Host

- H (Header)
- ..P (Patient)



- ..C (Patient Comments) Optional
- L (Terminator)

2.1.3. Structure of records for Result transmission

- H (Header)
- ..P (Patient)
- ..C (Patient Comments) Optional
-O (Order)
-C (Order Comments) Optional
-C (Run Alarms) Optional
- R (Result)
- C (Flag Result) Optional
- R (Result)
- C (Flag Result) Optional
-
-
- R (Result)
- C (Flag Result) Optional
- L (Terminator)

2.2. Description of Records

- Only the fields described with their specified length, in further tables, are used by ABX instruments.
- Length of field can be less than maximum value but must not be more.
- Only «Sample ID» and «Test» fields from Order record must be informed, all other fields are optional.
- Delimiter must be used even if field is free.
- Delimiters inside records are separate by «|» (ASCII \$7C).
- Delimiters inside fields are separate by «^» (ASCII \$5E).

2.2.1. Header record

Table 13: Header record fields

ASTM field	Definition	Transmitted data	Field max. length		
			P60C+	P80	PXL80
7.1.1	Record Type	H	1	1	1
7.1.2	Delimiters definition	idem standard: Field delimiter \ Repeat delimiter ^ Component delimiter & Escape delimiter	4	4	4
7.1.3	Message Control ID				
7.1.4	Access Password				
7.1.5	Sender Name	LIS	3	3	3
7.1.6	Sender Address				
7.1.7	Reserved				
7.1.8	Sender Telephone Nb				
7.1.9	Characteristics of Sender				
7.1.10	Receiver ID				
7.1.11	Comments or Special Instructions				
7.1.12	Processing ID	P	1	1	1
7.1.13	ASTM Version Nb	E 1394-97	9	9	9
7.1.14	Date and Time of message	YYYYMMDDHHMMSS	14	14	14

2.2.2. Patient record

Table 14: Patient record fields

ASTM field	Definition	Transmitted data	Field max. length		
			P60C+	P80	PXL80
8.1.1	Record Type	P	1	1	1
8.1.2	Sequence Nb	1, 2, ...	2	2	2
8.1.3	Practice Assigned Patient ID				
8.1.4	Laboratory Assigned Patient ID	Patient Id (Advised on PXL80 for workflow management)	30	25	25
8.1.5	Patient ID No 3				
8.1.6	Patient Name	Name^First name	30	20	20
8.1.7	Mother's Maiden Name				
8.1.8	Birthdate	YYYYMMDD	8	8	8
8.1.9	Patient Sex	M, F or U (see Note 1)	1	1	1
8.1.10	Patient Race-Ethnic Origin				
8.1.11	Patient Address				
8.1.12	Reserved				
8.1.13	Patient Telephone Nb				
8.1.14	Attending Physician ID	Text	15	20	20
8.1.15	Special Field 1				
8.1.16	Special Field 2				
8.1.17	Patient Height				
8.1.18	Patient Weight				
8.1.19	Patient's Known or Suspected Diagnosis				
8.1.20	Patient Active Medication				

Table 14: Patient record fields

ASTM field	Definition	Transmitted data	Field max. length		
			P60C+	P80	PXL80
8.1.21	Patient's Diet				
8.1.22	Practice Field 1				
8.1.23	Practice Field 2				
8.1.24	Admission and Discharge Dates				
8.1.25	Admission Status				
8.1.26	Location	Text	16	20	20
8.1.27	Nature of Alternative Diagnostic Code and Classifiers				
8.1.28	Nature of Alternative Diagnostic Code and Classifiers				
8.1.29	Patient Religion				
8.1.30	Marital status				
8.1.31	Isolation Status				
8.1.32	Language				
8.1.33	Hospital Service				
8.1.34	Hopital Institution				
8.1.35	Dosage Category				

• NOTE 1: M: Male, F: Female, U: Unspecified (If instrument receives an empty field (blank) it will use Unspecified type)

2.2.3. Order record

Table 15: Order record fields

ASTM field	Definition	Transmitted data	Field max. length		
			P60C+	P80	PXL80
9.4.1	Record Type	O	1	1	1
9.4.2	Sequence Nb	1, 2, ...	2	2	2
9.4.3	Sample ID	For PentraXL 80 see Note 2	16	16	22
9.4.4	Instrument Specimen ID				
9.4.5	Universal Test ID	^^^Test name (CBC or DIF) see Note 3	6	6	6
9.4.6	Priority				
9.4.7	Requested/Ordered Date and Time				
9.4.8	Specimen Collection Date and Time	YYYYMMDDHHMMSS	14	14	14
9.4.9	Collection End Time	YYYYMMDDHHMMSS	14	14	14
9.4.10	Collection Volume				
9.4.11	Collector ID				
9.4.12	Action Code				
9.4.13	Danger Code				
9.4.14	Relevant Clinical Informations				
9.4.15	Date/Time Specimen Received				
9.4.16	Specimen Descriptor	Text	20	20	20
9.4.17	Ordering Physician				
9.4.18	Physician Tel Nb				
9.4.19	User Field 1				
9.4.20	User Field 2				

Table 15: Order record fields

ASTM field	Definition	Transmitted data	Field max. length		
			P60C+	P80	PXL80
9.4.21	Laboratory Field 1				
9.4.22	Laboratory Field 2				
9.4.23	Date and Time Results reported or last modified				
9.4.24	Instrument Charge to Computer System				
9.4.25	Instrument Section ID				
9.4.26	Report Types	F: final C: correction For Pentra XL80 see Note 4	1	1	1
9.4.27	Reserved				
9.4.28	Location or Ward of Specimen Collection				
9.4.29	Nosocomial Infection Flag				
9.4.30	Specimen Service				
9.4.31	Specimen institution				

• NOTE 2: Field 9.4.3 «Sample ID» for PentraXL 80 (**Only from Instrument to Host**) is presented as follows:
SampleID^Rack(2 digits max.)^TubePosition(2 digits max.), Ex. 45264012^02^08

• NOTE 3: Field 9.4.5 «Universal test ID» must be necessarily filled by the type of analysis requested (CBC or DIF, See “Special characteristics for ABX datas”, page 19).

• NOTE 4: Field 9.4.26 «Report type» on PentraXL 80 depends on instrument unconditionnal validation mode state.
If results are unconditionally validated:
- F: Result validated
- I: Result unvalidated



If not:
 - F: First result
 - C: Resampling

2.2.4. Result record

Table 16: Result record fields

ASTM field	Definition	Transmitted data	Field max. length		
			P60C+	P80	PXL80
10.1.1	Record Type	R	1	1	1
10.1.2	Sequence Nb	1, 2, ...	2	2	2
10.1.3	Universal Test ID	^^^Result name in english^LOINC code For PentraXL 80 see Note 5	15	15	15
10.1.4	Data or Measurement Value	Test result (See "Special characteristics for ABX datas", page 19)			
10.1.5	Unit or Set of units (P80 V1.1 and above)	1, 2, 3 or 4		1	1
10.1.6	Reference Range				
10.1.7	Result Abnormal Flag	Analytical flag L,H,LL,HH,>	2	2	2
10.1.8	Nature of Abnormality Testing				

Table 16: Result record fields

ASTM field	Definition	Transmitted data	Field max. length		
			P60C+	P80	PXL80
10.1.9	Result Status	W: suspicion N: rejected result F: final result C: rerun result\or PLT concentrate (P80/XL80) X: Parameter exceeding the capacity (P80/XL80) M: Value input manually (PXL80) D: Value obtained by dilution (PXL80) For PentraXL 80 see Note 6	1	1	3
10.1.10	Date of Change in Normative Values or Units				
10.1.11	Operator Identification				
10.1.12	Date/Time Test Starting				
10.1.13	Date/Time Test Completed	YYYYMMDDHHMMSS	14	14	14
10.1.14	Instrument Identification				

- NOTE 5: Field 10.1.3 «Universal TestID» for PentraXL 80 includes the dilution ratio as follows: ^^^Result name in english^LOINC code^CDR (CDR=1 or 2 or 3 or 5).
- NOTE 6: Field 10.1.9 «Result Status» for PentraXL 80: If several indicators are required (max. 2) they are separated by «\» delimiter.

2.2.5. Comment record

Table 17: Comments record fields

ASTM field	Definition	Transmitted data	Field max. length		
			P60C+	P80	PXL80
11.1.1	Record Type	C	1	1	1
11.1.2	Sequence Nb	1, 2, ...	2	2	2
11.1.3	Comment Source	I clinical instrument system	1	1	1
11.1.4	Comment Text	Text (See Table Analytical alarms, See Table Analyzer alarms, See Table Suspected pathologies)	100	100	100
11.1.5	Comment Type	G:Free text I: Instrument flag comment L: Comment from host (Patient order) P80 V1.1 and above	1	1	1

2.2.6. Request information record (Query mode for PentraXL 80 Only)

Instrument request informations for only one tube at the time: 1 Request information record for each tube.

For example:

Instrument
Host
<ENQ>
<ACK>
<STX> 1H \^& ABX P E1394-97 20061124105356<CR><ETX>57<CR><LF>
<ACK>

<STX>	2Q 1 ^2312000 ALL O<CR><ETX>72<CR><LF>
<ACK>	
<STX>	3L 1 N<CR><ETX>06<CR><LF>
<ACK>	
<EOT>	

If Host had no information for the requested tube:

- Instrument receives an empty data frame: Only Header record and Terminator record with «Termination» code set at «\|», the instrument will apply a default profile for the tube.
- or
- Instrument applies default profile after a 25s timeout.

Table 18: Request information record fields (PentraXL 80 Only)

ASTM field	Definition	Transmitted data	Field max. length
			PentraXL 80
12.1.1	Record Type	Q	1
12.1.2	Sequence Nb	1	
12.1.3	Identifier	^Sample Id	16
12.1.4	End of identifier list		
12.1.5	Universal Test ID	ALL	3
12.1.6	Time limits		
12.1.7	Time max. limit		
12.1.8	Time min. limit		
12.1.9	Physician name		
12.1.10	Telephone number		
12.1.11	Reserve for user		
12.1.12	Reserve for user		
12.1.13	Status code	O: Query for test informations	1



2.2.7. Terminator record

Table 19: Terminator record

ASTM field	Definition	Transmitted data	Field max. length		
			P60C+	P80	PXL80
13.1.1	Record type	L	1	1	1
13.1.2	Sequence number	1	1	1	1
13.1.3	Termination code	N: Normal I: No information available for last query (P80XL Only)	1	1	1

3. Special characteristics for ABX datas

3.1. CBC Data presentation

Table 20: CBC Data presentation

Parameter	English code	Standard & Units P80 Set1	Units P80 Set2	Units P80 Set3	Units P80 Set4
White Blood Cell	WBC	10 ³ /mm ³	10 ⁹ /L	10 ⁹ /L	10 ² /mm ³
Red Blood Cell	RBC	10 ⁶ /mm ³	10 ¹² /L	10 ¹² /L	10 ⁴ /mm ³
Hemoglobin	HGB	g/dL	g/L	mmol/L	g/dL
Hematocrit	HCT	%	L/L	L/L	%
Mean Corpuscular Volume	MCV	µm ³	fL	fL	µm ³
Mean Corpuscular Hemoglobin	MCH	pg	pg	fmol	pg

Table 20: CBC Data presentation

Parameter	English code	Standard & Units P80 Set1	Units P80 Set2	Units P80 Set3	Units P80 Set4
Mean Corpuscular Hemoglobin Concentration	MCHC	g/dL	g/L	mmol/L	g/dL
Red Distribution Width	RDW	%	%	%	%
Platelets	PLT	10 ³ /mm ³	10 ⁹ /L	10 ⁹ /L	10 ³ /mm ³
Mean Platelet Volume	MPV	µm ³	fL	fL	µm ³
Plateletcrit	PCT	%	10 ¹² /L	10 ¹² /L	%
Platelet Distribution Width	PDW	%	%	%	%

3.2. DIF Data presentation

Table 21: DIF Data presentation

Parameter	English code	Standard & Units P80 Set1	Units P80 Set2	Units P80 Set3	Units P80 Set4
White Blood Cell	WBC	10 ³ /mm ³	10 ⁹ /L	10 ⁹ /L	10 ² /mm ³
Lymphocytes #	LYM#	10 ³ /mm ³	10 ⁹ /L	10 ⁹ /L	10 ² /mm ³
Lymphocytes %	LYM%	%	%	%	%
Monocytes #	MON#	10 ³ /mm ³	10 ⁹ /L	10 ⁹ /L	10 ² /mm ³
Monocytes %	MON%	%	%	%	%
Granulocytes #	GRA#	10 ³ /mm ³	10 ⁹ /L	10 ⁹ /L	10 ² /mm ³
Granulocytes %	GRA%	%	%	%	%
Neutrophils #	NEU#	10 ³ /mm ³	10 ⁹ /L	10 ⁹ /L	10 ² /mm ³
Neutrophils %	NEU%	%	%	%	%

Table 21: DIF Data presentation

Parameter	English code	Standard & Units P80 Set1	Units P80 Set2	Units P80 Set3	Units P80 Set4
Eosinophils #	EOS#	10 ³ /mm ³	10 ⁹ /L	10 ⁹ /L	10 ² /mm ³
Eosinophils %	EOS%	%	%	%	%
Basophils #	BAS#	10 ³ /mm ³	10 ⁹ /L	10 ⁹ /L	10 ² /mm ³
Basophils %	BAS%	%	%	%	%
Atypical Lymphocytes #	ALY#	10 ³ /mm ³	10 ⁹ /L	10 ⁹ /L	10 ² /mm ³
Atypical Lymphocytes %	ALY%	%	%	%	%
Large Immature Cell #	LIC#	10 ³ /mm ³	10 ⁹ /L	10 ⁹ /L	10 ² /mm ³
Large Immature Cell %	LIC%	%	%	%	%
Red Blood Cell	RBC	10 ⁶ /mm ³	10 ¹² /L	10 ¹² /L	10 ⁴ /mm ³
Hemoglobin	HGB	g/dL	g/L	mmol/L	g/dL
Hematocrit	HCT	%	L/L	L/L	%
Mean Corpuscular Volume	MCV	µm ³	fL	fL	µm ³
Mean Corpuscular Hemoglobin	MCH	pg	pg	fmol	pg
Mean Corpuscular Hemoglobin Concentration	MCHC	g/dL	g/L	mmol/L	g/dL
Red Distribution Width	RDW	%	%	%	%
Platelets	PLT	10 ³ /mm ³	10 ⁹ /L	10 ⁹ /L	10 ³ /mm ³
Mean Platelet Volume	MPV	µm ³	fL	fL	µm ³
Plateletcrit	PCT	%	10 ¹² /L	10 ¹² /L	%
Platelet Distribution Width	PDW	%	%	%	%

3.3. DIR Data presentation

Table 22: DIR Data presentation

Parameter	English code	Standard & Units P80 Set1	Units P80 Set2	Units P80 Set3	Units P80 Set4
White Blood Cell	WBC	10 ³ /mm ³	10 ⁹ /L	10 ⁹ /L	10 ² /mm ³
Lymphocytes #	LYM#	10 ³ /mm ³	10 ⁹ /L	10 ⁹ /L	10 ² /mm ³
Lymphocytes %	LYM%	%	%	%	%
Monocytes #	MON#	10 ³ /mm ³	10 ⁹ /L	10 ⁹ /L	10 ² /mm ³
Monocytes %	MON%	%	%	%	%
Granulocytes #	GRA#	10 ³ /mm ³	10 ⁹ /L	10 ⁹ /L	10 ² /mm ³
Granulocytes %	GRA%	%	%	%	%
Neutrophils #	NEU#	10 ³ /mm ³	10 ⁹ /L	10 ⁹ /L	10 ² /mm ³
Neutrophils %	NEU%	%	%	%	%
Eosinophils #	EOS#	10 ³ /mm ³	10 ⁹ /L	10 ⁹ /L	10 ² /mm ³
Eosinophils %	EOS%	%	%	%	%
Basophils #	BAS#	10 ³ /mm ³	10 ⁹ /L	10 ⁹ /L	10 ² /mm ³
Basophils %	BAS%	%	%	%	%
Atypical Lymphocytes #	ALY#	10 ³ /mm ³	10 ⁹ /L	10 ⁹ /L	10 ² /mm ³
Atypical Lymphocytes %	ALY%	%	%	%	%
Large Immature Cell #	LIC#	10 ³ /mm ³	10 ⁹ /L	10 ⁹ /L	10 ² /mm ³
Large Immature Cell %	LIC%	%	%	%	%
Red Blood Cell	RBC	10 ⁶ /mm ³	10 ¹² /L	10 ¹² /L	10 ⁴ /mm ³
Hemoglobin	HGB	g/dL	g/L	mmol/L	g/dL
Hematocrit	HCT	%	L/L	L/L	%

Table 22: DIR Data presentation

Parameter	English code	Standard & Units P80 Set1	Units P80 Set2	Units P80 Set3	Units P80 Set4
Mean Corpuscular Volume	MCV	µm ³	fL	fL	µm ³
Mean Corpuscular Hemoglobin	MCH	pg	pg	fmol	pg
Mean Corpuscular Hemoglobin Concentration	MCHC	g/dL	g/L	mmol/L	g/dL
Red Distribution Width	RDW	%	%	%	%
Reticulocytes #	RET#	10 ⁶ /mm ³	10 ¹² /L	10 ¹² /L	10 ⁴ /mm ³
Reticulocytes %	RET%	%	%	%	%
Reticulocytes (Low)	RETL%	%	%	%	%
Reticulocytes (Medium)	RETM%	%	%	%	%
Reticulocytes (High)	RETH%	%	%	%	%
Mean Fluorescence Index	MFI	%	%	%	%
Mean Reticulocyte Volume	MRV	µm ³	fL	fL	µm ³
Corrected Reticulocyte Concentration	CRC	%	%	%	%
Immature Reticulocytes	IMM%				
Immature Reticulocyte Fraction	IRF				
Platelets	PLT	10 ³ /mm ³	10 ⁹ /L	10 ⁹ /L	10 ³ /mm ³
Mean Platelet Volume	MPV	µm ³	fL	fL	µm ³
Plateletcrit	PCT	%	10 ¹² /L	10 ¹² /L	%
Platelet Distribution Width	PDW	%	%	%	%

3.4. Manual Input of parameters (PentraXL 80)

Table 23: Manual input of parameters Data presentation

Parameter	English code	Standard & Units P80 Set1	Units P80 Set2	Units P80 Set3	Units P80 Set4
Bands #	BND#	10 ³ /mm ³	10 ⁹ /L	10 ⁹ /L	10 ² /mm ³
Bands %	BND%	%	%	%	%
Metamyelocytes #	MET#	10 ³ /mm ³	10 ⁹ /L	10 ⁹ /L	10 ² /mm ³
Metamyelocytes %	MET%	%	%	%	%
Myelocytes #	MYE#	10 ³ /mm ³	10 ⁹ /L	10 ⁹ /L	10 ² /mm ³
Myelocytes %	MYE%	%	%	%	%
Promyelocytes #	PRO#	10 ³ /mm ³	10 ⁹ /L	10 ⁹ /L	10 ² /mm ³
Promyelocytes %	PRO%	%	%	%	%
Blasts #	BLA#	10 ³ /mm ³	10 ⁹ /L	10 ⁹ /L	10 ² /mm ³
Blasts %	BLA%	%	%	%	%
Others #	OTH#	10 ³ /mm ³	10 ⁹ /L	10 ⁹ /L	10 ² /mm ³
Others %	OTH%	%	%	%	%
Nrbc	NRBC	%	%	%	%

3.5. Alarms and Pathologies

ASTM specification reserved no field for pathologies. Pathology messages are sent through the comment record.

Each different type of alarm is transmitted through one different Comment record, a «I» (letter «i» in upper case) flag ended the Comment record and shows a warning from the instrument.



Example:

- H|\^&|||ABX|||||P|E1394-97|20010413105547
- ..P|1||||SANTOS^JeanPhilippe|||||FRICH Philippe
-O|1|0002|7|^^^DIF|||||F
- R|1|^^^WBC^804-5|5.26|10e3/mm3||L||F
- C|1||^L1^LL^NL^LL1||

3.5.1. Analytical alarms

Analytical alarms are transmitted through one Comment record located after the corresponding Result record.

Table 24: Analytical alarms

Alarm type	All instruments	Pentra 80/XL80 Only	All instruments except Pentra 80/XL80
ALARM_WBC	MB, CO, NE, LL, NL, MN, LN, RM, RN, NO, LB,, BASO, WBC1, WBC2, Baso+, Baso-	LMNE+, LMNE-, SL1	L1, MP, LI1, M1, M2, G1, G2, G3, Lmne+, Lmne-
ALARM_RBC		Mi, MA	Mi, Ma
ALARM_PLT	PC, MC, SC		
ALARM_RET	Low, Las, Pit, Fit, Nrbc		

3.5.2. Analyzer alarms

Analyzer's alarms are transmitted through the Comment record located after the Order record.

Table 25: Analyzer alarms

Alarm type	All instruments	Pentra 80 only
ALARM_ANALYSER	XB, XR, QC, WESTGARD, STARTUP FAILED, STARTUP NOTDONE, STARTUP NOTEFFECTIVE, FOR INVESTIGATIONAL USE ONLY	MANUAL MATCH, RECALCULATED

3.5.3. Suspected pathologies

Suspected pathologies are transmitted through one Comment record located after corresponding Result record. If several pathologies are suspected they will be separate by the component delimiter.

Table 26: Suspected pathologies

Populations	Messages	French
WBC	LEUCOCYTOSIS	Leucocytose
	LEUCOPENIA	Leucopénie
	LYMPHOCYTOSIS	Lymphocytose
	LYMPHOPENIA	Lymphopénie
	NEUTROPHILIA	Neutrophilie
	NEUTROPENIA	Neutropénie
	EOSINOPHILIA	Eosinophilie
	MYELEMIA	Myélemie
	LARGE IMMATURE CELL	Grandes Cellules Immatures
	ATYPICAL LYMPHOCYTE	Lymphocytes atypiques
	LEFT SHIFT	Formule Gauche
	NRBCs	Erythroblastes
	MONOCYTOSIS	Monocytose
	BASOPHILIA	Basophilie

Table 26: Suspected pathologies

Populations	Messages	French
	BLASTS	Blastes
	PANCYTOPENIA	Pancytopénie
	WBC INTERPRETATION IMPOSSIBLE	Interprétation GB impossible
RBC	ANEMIA	Anémie
	ANISOCYTOSIS	Anisocytose degré 1
	ANISOCYTOSIS+	Anisocytose degré 2
	ANISOCYTOSIS++	Anisocytose degré 3
	MICROCYTES	Microcytes degré 1
	MICROCYTES+	Microcytes degré 2
	MICROCYTES++	Microcytes degré 3
	MACROCYTES	Macrocytes degré 1
	MACROCYTES+	Macrocytes degré 2
	MACROCYTES++	Macrocytes degré 3
	MICROCYTOSIS	Microcytose
	MACROCYTOSIS	Macrocytose
	HYPOCHROMIA	Hypochromie degré 1
	HYPOCHROMIA+	Hypochromie degré 2
	HYPOCHROMIA++	Hypochromie degré 3
	COLD AGGLUTININES	Agglutinine froide
	PANCYTOPENIA	Pancytopénie
	RBC INTERPRETATION IMPOSSIBLE	Interprétation GR impossible
PLT	THROMBOCYTOSIS	Thrombocytose
	THROMBOPENIA	Thrombopénie
	PLATELET AGGREGATS	Agrégats plaquettaires

Table 26: Suspected pathologies

Populations	Messages	French
	SMALL CELLS	Petits éléments cellulaires
	MICROCYTES	Microcytes
	SCHIZOCYTES	Schisocytes
	MACROPLATELETS	Macro plaquettes
	PANCYTOPENIA	Pancytopénie
	PLT INTERPRETATION IMPOSSIBLE	Interprétation Pla impossible

3.5.4. Suspicion and Reject

When one result is suspected abnormal or false, that means result is not reliable, the instrument returns a flag in field 10.1.9 (See Table 16, “Result record fields”, page 17).

3.5.5. Normal and Panic ranges

Flags when result exceeds Normal or Panic ranges are transmitted through field 10.1.7, they should be compared, to get a full result information, to the ranges set by the user, these low and high limits can be transmitted through field 10.1.6 (See Table 16, “Result record fields”, page 17).

4. Management of errors

4.1. During Instrument transmission

During a single result transmission by the instrument, if the host lost the transmission (Time-Out or EOT) the full message will be transmitted again after a paramettable delay (10s by default).

In case of long files with several results the re-transmission will be done from the result lost to the end.



After 6 consecutive NAKs detected the sent file is deferred to later transmission.

4.2. During Host transmission

According to E-1381 protocol, error management of Time-out, Checksum and frame number, in case of none respect of these norms, will return NAK (or communication will be halted). In case of transmission of long files (Worklist upload for example), files previously transmitted before transmission error will be interpreted and managed by the instrument, others will not be used.

According to E-1394 protocol, all Orders without «Sample ID» or with «Sample ID» superiors to 16 characters, will not be interpreted by the instrument. (Pentra80 will acknowledge and trigger an alarm off, on the instrument and Pentra 80 Host.log is updated).

In case of «Patient ID» field empty or too long, but with a correct «Sample Id», the Order will be interpreted, but result will be returned with an auto-patient ID set by the instrument. Pentra 80 V1.1 and above will reject the Order.

All other too long fields will be cut to fit to ASTM field specified length, except for Pentra 80 V1.1 and above: Packet is ignored (A notification is made into the Host.log).

5. Example of data frame

5.1. Example of Order sent by Host

- Patient ID: PID12345
- Patient Name: LASTNAME, FIRSTNAME
- Birthdate: 23/12/1964
- Prescriptor: Prescriptor
- Department: Location
- Sample ID (mandatory field): SID007

- Test (mandatory field): CBC

Table 27: Example of Order sent by Host

Host
Instrument
<ENQ>
<ACK>
<STX>1H ^& ABX P 1394-97 20031202102713<CR><ETX>06<CR><LF>
<ACK>
<STX>2P 1 PID12345 LASTNAME^FIRSTNAME 19641223 M Prescriptor Loca- tion<CR><ETX>D6<CR><LF>
<ACK>
<STX>3C 1 Patient Comment<CR><ETX>3C<CR><LF>
<ACK>
<STX>4O 1 SID007 ^C^CBC R A<CR><ETX>04<CR><LF>
<ACK>
<STX>5C 1 Order Comment<CR><ETX>65<CR><LF>
<ACK>
<STX>6L 1 N<CR><ETX>09<CR><LF>
<ACK>
<EOT>

5.2. Example of Result sent by instrument

Table 28: Example of Result sent by instrument

Instrument
Host
<ENQ>
<ACK>



Table 28: Example of Result sent by instrument

```

<STX>1H|^&|||ABX|||||P|E1394-97|20020725100331<CR><ETX>4D<CR><LF>
<ACK>
<STX>2P|1||AUTO_PID1381||CATHELIN||19260813<CR><ETX>4F<CR><LF>
<ACK>
<STX>3O|1|25028||^DIF|||||||||F<CR><ETX>13<CR><LF>
<ACK>
<STX>4R|1|^WBC^804-5|3.45|10e3/mm3||LL||F<CR><ETX>D6<CR><LF>
<ACK>
<STX>5C|1||LEUCOPENIA^LYMPHOPENIA^NEUTROPENIA^EOSINOPHILIA^MONOCYTOSIS||<CR>
><ETX>C4<CR><LF>
<ACK>
<STX>6R|2|^LYM#^731-0|0.78||LL||F<CR><ETX>DA<CR><LF>
<ACK>
<STX>7R|3|^LYM%^736-9|22.50|%||LL||F<CR><ETX>3B<CR><LF>
<ACK>
<STX>0R|4|^MON#^742-7|0.42||||F<CR><ETX>36<CR><LF>
<ACK>
<STX>1R|5|^MON%^744-3|12.20|%||HH||F<CR><ETX>1C<CR><LF>
<ACK>
<STX>2R|6|^NEU#^751-8|1.99||LL||F<CR><ETX>DE<CR><LF>
<ACK>
<STX>3R|7|^NEU%^770-8|57.70|%||||F<CR><ETX>A0<CR><LF>
<ACK>
<STX>4R|8|^EOS#^711-2|0.26||||F<CR><ETX>34<CR><LF>
<ACK>
<STX>5R|9|^EOS%^713-8|7.40|%||HH||F<CR><ETX>F8<CR><LF>
<ACK>
<STX>6R|10|^BAS#^704-7|0.01||||F<CR><ETX>4E<CR><LF>
  
```

Table 28: Example of Result sent by instrument

```

<ACK>
<STX>7R|11|^BAS%^706-2|0.20|%||||F<CR><ETX>75<CR><LF>
<ACK>
<STX>0R|12|^ALY#^733-6|0.07||||F<CR><ETX>61<CR><LF>
<ACK>
<STX>1R|13|^ALY%^735-1|1.89|%||||F<CR><ETX>92<CR><LF>
<ACK>
<STX>2R|14|^LIC#^X-LIC|0.03||||F<CR><ETX>B0<CR><LF>
<ACK>
<STX>3R|15|^LIC%^11117-9|0.80|%||||F<CR><ETX>E2<CR><LF>
<ACK>
<STX>4R|16|^RBC^789-9|4.43|10e6/mm3||||F<CR><ETX>81<CR><LF>
<ACK>
<STX>5R|17|^HGB^717-9|13.47|g/dl||||F<CR><ETX>D6<CR><LF>
<ACK>
<STX>6R|18|^HCT^4544-3|38.95|%||||F<CR><ETX>DB<CR><LF>
<ACK>
<STX>7R|19|^MCV^787-2|87.94|µm3||||F<CR><ETX>EB<CR><LF>
<ACK>
<STX>0R|20|^MCH^785-6|30.40|pg||||F<CR><ETX>3D<CR><LF>
<ACK>
<STX>1R|21|^MCHC^786-4|34.57|g/dl||||F<CR><ETX>1C<CR><LF>
<ACK>
<STX>2R|22|^RDW^788-0|13.49|%||||F<CR><ETX>AB<CR><LF>
<ACK>
<STX>3R|23|^PLT^777-3|186.74|10e3/mm3||||F<CR><ETX>FA<CR><LF>
<ACK>
<STX>4R|24|^MPV^776-5|8.45|µm3||||F<CR><ETX>B7<CR><LF>
  
```

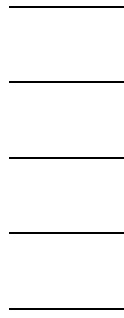
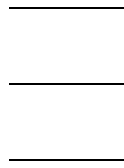

Table 28: Example of Result sent by instrument

<ACK>
<STX>5R 25 ^^PCT^X-PCT 0.16 % F<CR><ETX>D9<CR><LF>
<ACK>
<STX>6R 26 ^^PDW^X-PDW 14.50 % F<CR><ETX>16<CR><LF>
<ACK>
<STX>7L 1 N<CR><ETX>40<CR><LF>
<ACK>
<EOT>





Chapter 4

ABX Format



ABX Format

ASTM Format is recommended by ABX Diagnostics for every new connection development. ABX Format, is currently supported to be compliant with earlier instruments or existing connections.

1. Overview

- ABX format supports unidirectional or bidirectional connections.
- ABX format can have a different numbers of fields according to the transmitted items setup by the user (results, curves, flags, etc...) or to the type of cycle.
- Fields sequence is not fixed.
- The result identifier is different according to the type of result: patient result ("RESULT"), re-run result (RES-RR), QC result (QC-RES) etc... (See Table 4, "Data transmitted by the host to the analyzer", page 30).

2. Protocol description

2.1. Unidirectional mode

2.1.1. Typical unidirectional transmission from Instrument to Host

Table 29: Typical unidirectional transmission from Instrument to Host

Instrument	<>	Host	Comment
<STX> + RESULT + <ETX>	>		

2.1.2. Typical unidirectional transmission from Instrument to Host with «SOH»\»EOT»

«SOH»\»EOT» option must be enabled on the instrument.

Table 30: Typical unidirectional transmission with «SOH»\»EOT» from Instrument to Host

Instrument	<>	Host	Comment
<SOH>	>		instrument take the Line
<STX> + RESULT + <ETX>	>		
	.		
	.		
	.		
<STX> + RESULT + <ETX>	>		
<EOT>	>		instrument free the Line

2.2. Bidirectional mode

2.2.1. Typical bidirectional transmission from Host to Instrument

Table 31: Typical transmission from Host to Instrument

Host	<>	Instrument	Comment
<SOH>	>		Host take the Line
	<	<ENQ>	
<STX> + FILE + <ETX>	>		
	<	<ACK>	
	.		
	.		



Table 31: Typical transmission from Host to Instrument

Host	<>	Instrument	Comment
	.		
<STX> + END + <ETX>	>		Host free the Line
	<	<ACK>	

2.2.2. Typical bidirectionnal transmission from Instrument to Host

Table 32: Typical transmission from Instrument to Host

Instrument	<>	Host	Comment
<SOH>	>		instrument take the Line
	<	<ENQ>	
<STX> + RESULT + <ETX>	>		
	<	<ACK>	
	.		
	.		
	.		
<STX> + END + <ETX>	>		instrument free the Line
	<	<ACK>	

2.3. Conflict management

Number of transmission if negative answer (NACK): 1

Timeout: 15s

In case of SOH/SOH conflict, priority is given to Host. After an adjustable delay (8s by default) and if Host has not re-sent a SOH, instrument will try to send SOH again until timeout. This will be done until automatic disconnection max time is reached.

3. Message structure

3.1. Lines structure

- STX
 - Size + carriage return (Size: 5 bytes representing the total amount of the data except STX and ETX).
 - Identifier followed by a Load Type + carriage return (Load: An 8 character chain preceded by a space indicating the type of datas.).
 - Identifier followed by the Information associated to the Load Type + carriage return (Identifier: 1 byte moving about \$21 to \$FF (See NOTE 7), it describes the information type which follows this indicator, always followed by a space charcater \$20).
 - Remainder of the other Identifiers and Informations associated to the Load Type + carriage returns.
 - Other Load Type blocs + Associated Informations.
-
- Identifier followed by the CheckSum + carriage return (Checksum: Sum modulo 65536 of all the characters except ETX, STX and all informations about checksum (identifier - space - checksum - carriage return) in the hexadecimal format on 4 bytes, preceded by a space character \$20).
 - ETX

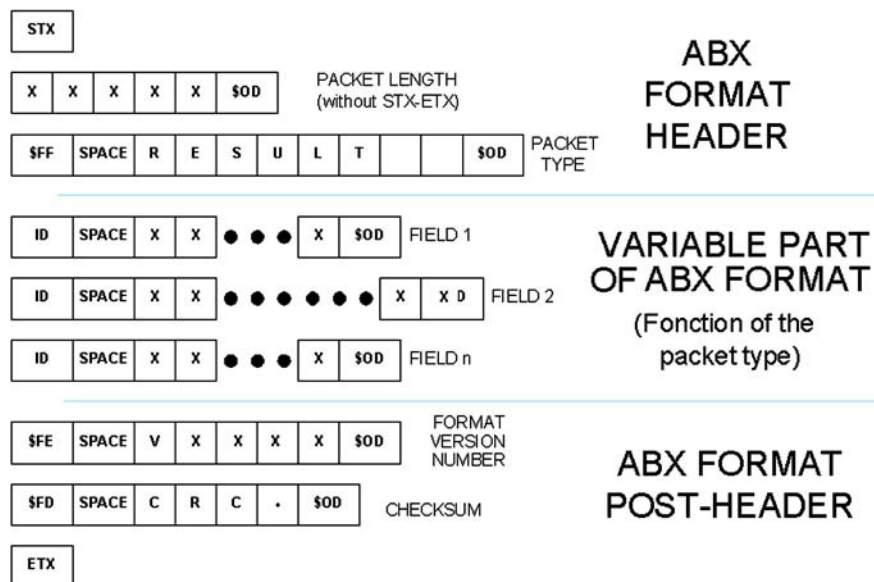

Diag.1: ABX format line structure

3.2. Control characters

Table 33: Standard control characters

Control String	Hexadecimal value
<ENQ>	\$05
<ACK>	\$06
<NAK>	\$15
<STX>	\$02

Table 33: Standard control characters

Control String	Hexadecimal value
<ETX>	\$03
<CR>	\$0D
<LF>	\$0A
<EOT>	\$04
<SOH>	\$01

4. Data transmitted by the host to the analyzer

Data packet files will be available only if the instrument has been setup with the remote controlled mode.

"FILE" request:

The data packet "FILE" will be followed by \$75 or \$76 representing the patient file in order to obtain the type of test to be run on the corresponding sample.

Table 34: Example of transmission between Host and Instrument

Flow	Dataflow	Comments
Instrument>Host	\$01	Pentra sends SOH
Host>Instrument	\$05	Host responds ENQ
Instrument>Host	\$02\$FF FILE \$0D \$75 123456789012 \$0D \$03	Pentra sends STX + First Query Message + ETX...
Host>Instrument	\$06	Host responds ACK
Instrument>Host	Pentra sends STX + Next Query Message + ETX
Host>Instrument	\$06	Host responds ACK
Instrument>Host	Pentra sends STX + Last Query Message + ETX

Table 34: Example of transmission between Host and Instrument

Flow	Dataflow	Comments
Host>Instrument	\$06	Host responds ACK
Instrument>Host	\$0200043\$0D \$FF END \$0D \$03	Pentra sends STX + Free line + ETX
Host>Instrument	\$06	Host responds ACK

Each data packet "FILE" will be preceded and followed by STX and ETX. Several requests of this type can be chained between a line bid and a line free in order to organize the grouping of the requests for the instruments equipped with an automatic sampling mode.

Table 35: Data packet strings

Data packet string	Use
FILE	Patient file
END	Line free message

Patient identification:

- All the described fields have a fixed size character string type and are completed with spaces on the righthand side for the non significant informations.
- n= number
- c= character

Table 36: Identifier list (Host to Instrument)

Identifier	Correspondance	Exemple	Length	Format	Transmission	See Note
\$70 p	Analyzer number	01	2+2+1	Integers	required	
\$75 u	Id # or sample id.	1450302154275-42	2+16+1	String(16)	required	
\$76 v	Id. or patient name	SMITH Ronald	2+30+1	String(30)	required	
\$77 w	Birth date	YYYYMMDD	2+8+1	nnnnnnnn	optional	8
\$78 x	Age	7d or 4w or 10m or 54y or 100	2+3+1	String(3)	advised	9
\$79 y	Sex	0, 1 or 2	2+1+1	String(1)	advised	10
\$7A z	Origin	x	2+1+1	String(1)	optional	
\$7B {	Doctor	Dr Jones	2+15+1	String(15)	optional	
\$7C	Department	Cardiology	2+10+1	String(10)	optional	
\$7D }	Collection date	06/08/99 13h15	2+14+1	nn/nn/nn nnhnn	optional	11
\$7E ~	Comments		2+32+1	String(32)	optional	
\$7F	Blood type	man	2+16+1	String(16)	optional	12
\$80 ç	Analysis type	A	2+1+1	String(1)	advised	13
\$89 ë	SPS smearing mode	ECC	2+3+1	String(3)	optional	14
\$8A è	SPS smearing profile	65G4	2+4+1	String(4)	optional	15
\$8B ï	Patient identification	200205125751	2+30+1	String(30)	advised	16



• NOTE 7: (Pentra 80 V1.1 and above)
Characters supported goes from \$20 to \$7F for all languages, except for Japanese from \$20 to \$FF. No accent is accepted into fields.



- NOTE 8 (\$77)

For all instruments: There is no check on \$77 compare to \$78.
 Pentra 80 V1.1 and above: If date is invalid, Birthdate > Date of day, Month or Day incoherent, packet will be ignored.

- NOTE 9 (\$78)

\$78 is a 3 characters string completed on the right handside by "spaces".
 If age exceeded 99 years, the 3 characters of the string are used for the age without unit (example: 102).
 Pentra 60C+ & 80 V1.1 and above: Age is recalculated if Birthdate (\$78) is different.

- NOTE 10 (\$79)

0 or Blank: Unspecified, 1: Male, 2: Female

- NOTE 11 (\$7D)

Only Pentra 80 V1.1 and above: Collection date formats are: YY/MM/DD HHhMM or YYYYMMDD HHhMM. Packet will be ignored date or time are incoherent.

- NOTE 12 (\$7F)

\$7F must be one of the instrument blood type list. If not, it will be generated according to the age (\$78) or for adults by the sex (\$79).

- NOTE 13 (\$80)

See tables page 4 & page 5 to see test compatibility with the instrument:

- 'A': CBC
- 'B': DIF (CBC+DIF)
- 'C': RET
- 'D': LMG (CBC+LMG)
- 'E': CBR (CBC+RET)
- 'F': DIR (CBC+DIF+RET)
- 'G': SPS Etalement lame sans analyse
- '@': Resampling and reflex testing

- NOTE 14 (\$89)

First character is «Space» +3 charcaters ECC:
 E: Smearing

C: Staining

C: Criteria

When the file is received without \$89, the default type is applied.

Table 37: ECC combinations

E	C	C	Action
E	C	C	A slide for Smearing and Staining will be done before test. A slide could be done after test, according to instrument Reflex testing conditions
E	C	Space	A slide for Smearing and Staining will be done before test. Reflex testing conditions are inhibited
E	Space	Space	A slide for Smearing will be done before test. Reflex testing conditions are inhibited
E	Space	C	A slide for Smearing will be done before test. A slide could be done after test, according to instrument Reflex testing conditions
Space	Space	C	No Slide Before test. A slide could be done after test, according to instrument Reflex testing conditions
Space	Space	Space	No Slide Before test. Reflex testing conditions are inhibited

- NOTE 15 (\$8A)

\$8A must be one of the instrument Smearing profile that defines: Drop volume, angle and speed.

- NOTE 16 (\$8B)

On Pentra 60C+ and Pentra 80/XL80 the Patient ID field must NOT be empty otherwise the test will NOT be done.
 On Pentra 120: This field is not compatible with Pentra 120.

5. Data transmitted by the analyzer to the host

5.1. Packet type

The information described in the packet type allows the specification of the global message content: hematological routine results or statistic results.

Table 38: Packet type list

Data packet string (8 char.)	Use	Comment
RESULT	Hematological result transmission on a routine mode	
RES-RR	Hematological result transmission on automatic re-sampling mode	
REASSESS	Result transmission of a recalculated sample using the recalculation user function	P80/XL80: Not transmitted
QC-RES-H	Result transmission of a high level control blood	P80/XL80: Not transmitted
QC-RES-M	Result transmission of a median level control blood	P80/XL80: QC-LMMH transmission
QC-RES-L	Result transmission of a low level control blood	P80/XL80: Not transmitted
FILE	Patient file request	
END	Connection end	
RES-BLK	Blank cycle results	P80 Only

5.2. Identifier list (Instrument to Host)

Table 39: Identifier list (Instrument to Host)

Identifier	Correspondance	Exemple	Length	Format	See Note
\$70 p	Analyzer number	01	2+2+1	Integers	
\$71 q	Analysis date and time	03/01/05 13h15mn31s	2+19+1	String(19)	17
\$72 r	Analyzer run number	115 or 005CBC06	2+16+1	String(16)	18
\$73 s	Analyzer sequence number				

Table 39: Identifier list (Instrument to Host)

Identifier	Correspondance	Exemple	Length	Format	See Note
\$74 t	Sampling mode	M: manual (open tube) R: rack (close tube)	2+1+1	String(1)	
\$75 u	Id # or sample id.	1450302154275-42	2+16+1	String(16)	
\$76 v	Id. or patient name	SMITH Ronald	2+30+1	String(30)	
\$77 w	Birth date	16/03/72 or 03161972	2+8+1	nn/nn/nn or nnnnnnnn	19
\$78 x	Age	7d or 4w or 10m or 54y or 100	2+3+1	String(3)	
\$79 y	Sex	0, 1 or 2	2+1+1	String(1)	10
\$7A z	Origin	x	2+1+1	String(1)	
\$7B {	Doctor	Dr Jones	2+15+1	String(15)	
\$7C	Department	Cardiology	2+10+1	String(10)	
\$7D }	Collection date	06/08/99 13h15	2+14+1	nn/nn/nn nnhnn	11
\$7E ~	Comments		2+32+1	String(32)	
\$7F	Blood type	man	2+16+1	String(16)	12
\$80 ç	Analysis type	A	2+1+1	String(1)	13
\$81 ü	Sample rack type	0: 10 positions 1: 15 positions 2: 32 positions	2+1+1	Integer	
\$82 é	Number of runs	0, 1, ...	2+1+1	Integer	
\$83 â	Operator code	Bob	2+3+1	String(3)	



- NOTE 17 (\$71)
Pentra 80 V1.1 and above: Valid date format is YY/MM/DD HHhMMmSSs
- NOTE 18 (\$72)



Pentra 80XL: Informations about the rack number, the type of test and the tube position.

Rack number: From 001 to 999

Test: CBC or DIF

Tube position: From 01 to 10

- NOTE 19 (\$77)

Pentra 80 V1.1 and above: Valid date format is YY/MM/DD

5.2.1. Numerical result fields

The numerical result filed format is 5 digits completed with zeros on the left. Units are standard units.

If one parameter cannot be calculated by the analyzer, the field is replaced with --.--

Parameter status:

Following the numerical field, a first digit gives the counting rejection status or the suspicion, a second one gives the parameter value status according to high and low normalities, to high and low extreme values and to the overloading capacities.

Table 40: Identifier First digit

First digit (letter)	Correspondance	Comment
R	Parameter rejected for a counting default	
B	Incorrect balance between the counting methods	P80: Not transmitted
S	Suspicious parameter value	
M	Value input manually	Pentra XL 80
D	Value obtained by dilution	Pentra XL 80
'space'	No anomaly observed	

Table 41: Identifier Second digit

Second digit (letter)	Correspondance	Comment
B (french) or L (other languages)	Parameter < to the lower extreme value	P80/XL80: Only «L»
b (french) or l (other languages)	Parameter < to the low normal value	P80/XL80: Only «l»
'space'	Parameter normal value	
h	Parameter > to the high normal value	
H	Parameter > to the high extreme value	
C	Platelet concentrate	Pentra 80 V1.1 and above
O	Parameter exceeding the capacity	

Example:

5.5 millions RBC with a counting error in the standard units:

\$32 \$20 \$30 \$35 \$2E \$35 \$30 \$52 \$68 \$0D or «2 05.50Rh» + carriage return.

Table 42: Pentra 80XL Identifier Third digit

Third digit (letter)	Correspondance
D	Parameter obtained by dilution ratio other than 1
'space'	Parameter normal value

Table 43: Pentra 80XL Identifier Fourth digit

Fourth digit (letter)	Correspondance
'space'	For further use

Table 44: Pentra 80XL Identifier Fifth digit

Fifth digit (letter)	Correspondance
'space'	For further use

Example for Pentra 80XL:

5.5 millions RBC with a counting error in the standard units:

\$32 \$20 \$30 \$35 \$2E \$35 \$30 \$52 \$68 \$44 \$20 \$20 \$0D or «2 05.50RhD » + carriage return.

See tables page 4 & page 5 to check possible type of analyses according to instrument capabilities.

Table 45: CBC numerical result fields list

Identifier	Correspondance	Example	All instruments (except PXL80) Format (Length)	PXL 80 Format (Length)
\$21 !	WBC	07.40	2+String(7)+1	2+String(10)+1
\$32 2	RBC	04.64	2+String(7)+1	2+String(10)+1
\$33 3	Hgb	14.17	2+String(7)+1	2+String(10)+1
\$34 4	Hct	43.95	2+String(7)+1	2+String(10)+1
\$35 5	MCV	94.68	2+String(7)+1	2+String(10)+1
\$36 6	MCH	30.53	2+String(7)+1	2+String(10)+1
\$37 7	MCHC	32.24	2+String(7)+1	2+String(10)+1
\$38 8	RDW	12.98	2+String(7)+1	2+String(10)+1
\$40 @	PLT	00401	2+String(7)+1	2+String(10)+1
\$41 A	MPV	07.94	2+String(7)+1	2+String(10)+1
\$42 B	THT	0.318	2+String(7)+1	2+String(10)+1
\$43 C	PDW	13.50	2+String(7)+1	2+String(10)+1

Table 46: DIF numerical result fields list

Identifier	Correspondance	Example	All instruments (except PXL80) Format (Length)	PXL 80 Format (Length)
\$21 !	WBC	07.40	2+String(7)+1	2+String(10)+1
\$22 "	Lymphocytes (#)	02.03	2+String(7)+1	2+String(10)+1
\$23 #	Lymphocytes (%)	27.40	2+String(7)+1	2+String(10)+1
\$24 \$	Monocytes (#)	00.70	2+String(7)+1	2+String(10)+1
\$25 %	Monocytes (%)	09.40	2+String(7)+1	2+String(10)+1
\$28 (Neutrophils (#)	04.51	2+String(7)+1	2+String(10)+1
\$29)	Neutrophils (%)	60.90	2+String(7)+1	2+String(10)+1
\$2A *	Eosinophils (#)	00.13	2+String(7)+1	2+String(10)+1
\$2B +	Eosinophils (%)	01.70	2+String(7)+1	2+String(10)+1
\$2C ,	Basophils (#)	00.04	2+String(7)+1	2+String(10)+1
\$2D -	Basophils (%)	00.60	2+String(7)+1	2+String(10)+1
\$2E .	Atypical Lymphocytes (#)	00.11	2+String(7)+1	2+String(10)+1
\$2F /	Atypical Lymphocytes (%)	01.49	2+String(7)+1	2+String(10)+1
\$30 0	Large Immature Cells (#)	00.03	2+String(7)+1	2+String(10)+1
\$31 1	Large Immature Cells (%)	00.43	2+String(7)+1	2+String(10)+1
\$32 2	RBC	04.64	2+String(7)+1	2+String(10)+1
\$33 3	Hgb	14.17	2+String(7)+1	2+String(10)+1
\$34 4	Hct	43.95	2+String(7)+1	2+String(10)+1
\$35 5	MCV	94.68	2+String(7)+1	2+String(10)+1
\$36 6	MCH	30.53	2+String(7)+1	2+String(10)+1
\$37 7	MCHC	32.24	2+String(7)+1	2+String(10)+1
\$38 8	RDW	12.98	2+String(7)+1	2+String(10)+1
\$40 @	PLT	00401	2+String(7)+1	2+String(10)+1

Table 46: DIF numerical result fields list

Identifier	Correspondance	Example	All instruments (except PXL80) Format (Length)	PXL 80 Format (Length)
\$41 A	MPV	07.94	2+String(7)+1	2+String(10)+1
\$42 B	THT	0.318	2+String(7)+1	2+String(10)+1
\$43 C	PDW	13.50	2+String(7)+1	2+String(10)+1

Table 47: RET numerical result fields list

Identifier	Correspondance	Example	All instruments (except PXL80) Format (Length)	PXL 80 Format (Length)
\$32 2	RBC	04.64	2+String(7)+1	2+String(10)+1
\$3B ;	Reticulocytes (#)	0656	2+String(7)+1	2+String(10)+1
\$3C <	Reticulocytes (%)	01.41	2+String(7)+1	2+String(10)+1
\$3D =	Reticulocytes Low (%)	80.34	2+String(7)+1	2+String(10)+1
\$3E >	Reticulocytes Median (%)	14.96	2+String(7)+1	2+String(10)+1
\$3F ?	Reticulocytes High (%)	04.90	2+String(7)+1	2+String(10)+1
\$47 G	Retic Immatures	00.02	2+String(7)+1	2+String(10)+1
\$48 H	Mean fluorescent index (%)	17.97	2+String(7)+1	2+String(10)+1
\$49 I	Mean reticulocyte vol.	107.5	2+String(7)+1	2+String(10)+1
\$4A J	Corrected ret. count (%)	01.38	2+String(7)+1	2+String(10)+1
\$4C L	IRF	.0500	2+String(7)+1	2+String(10)+1

Table 48: LMG numerical result fields list

Identifier	Correspondance	Example	All instruments (except PXL80) Format (Length)	PXL 80 Format (Length)
\$21 !	WBC	07.40	2+String(7)+1	2+String(10)+1
\$22 "	Lymphocytes (#)	02.03	2+String(7)+1	2+String(10)+1
\$23 #	Lymphocytes (%)	27.40	2+String(7)+1	2+String(10)+1
\$24 \$	Monocytes (#)	00.70	2+String(7)+1	2+String(10)+1
\$25 %	Monocytes (%)	09.40	2+String(7)+1	2+String(10)+1
\$26 &	Granulocytes (#)	04.67	2+String(7)+1	2+String(10)+1
\$27 '	Granulocytes (%)	63.20	2+String(7)+1	2+String(10)+1
\$32 2	RBC	04.64	2+String(7)+1	2+String(10)+1
\$33 3	Hgb	14.17	2+String(7)+1	2+String(10)+1
\$34 4	Hct	43.95	2+String(7)+1	2+String(10)+1
\$35 5	MCV	94.68	2+String(7)+1	2+String(10)+1
\$36 6	MCH	30.53	2+String(7)+1	2+String(10)+1
\$37 7	MCHC	32.24	2+String(7)+1	2+String(10)+1
\$38 8	RDW	12.98	2+String(7)+1	2+String(10)+1
\$40 @	PLT	00401	2+String(7)+1	2+String(10)+1
\$41 A	MPV	07.94	2+String(7)+1	2+String(10)+1
\$42 B	THT	0.318	2+String(7)+1	2+String(10)+1
\$43 C	PDW	13.50	2+String(7)+1	2+String(10)+1

Table 49: CBR numerical result fields list

Identifier	Correspondance	Example	All instruments (except PXL80) Format (Length)	PXL 80 Format (Length)
\$21 !	WBC	07.40	2+String(7)+1	2+String(10)+1
\$32 2	RBC	04.64	2+String(7)+1	2+String(10)+1
\$33 3	Hgb	14.17	2+String(7)+1	2+String(10)+1
\$34 4	Hct	43.95	2+String(7)+1	2+String(10)+1
\$35 5	MCV	94.68	2+String(7)+1	2+String(10)+1
\$36 6	MCH	30.53	2+String(7)+1	2+String(10)+1
\$37 7	MCHC	32.24	2+String(7)+1	2+String(10)+1
\$38 8	RDW	12.98	2+String(7)+1	2+String(10)+1
\$3B ;	Reticulocytes (#)	.0656	2+String(7)+1	2+String(10)+1
\$3C <	Reticulocytes (%)	01.41	2+String(7)+1	2+String(10)+1
\$3D =	Reticulocytes Low (%)	80.34	2+String(7)+1	2+String(10)+1
\$3E >	Reticulocytes Median (%)	14.96	2+String(7)+1	2+String(10)+1
\$3F ?	Reticulocytes High (%)	04.90	2+String(7)+1	2+String(10)+1
\$40 @	PLT	00401	2+String(7)+1	2+String(10)+1
\$41 A	MPV	07.94	2+String(7)+1	2+String(10)+1
\$42 B	THT	0.318	2+String(7)+1	2+String(10)+1
\$43 C	PDW	13.50	2+String(7)+1	2+String(10)+1
\$47 G	Retic Immatures	00.02	2+String(7)+1	2+String(10)+1
\$48 H	Mean fluorescent index (%)	17.97	2+String(7)+1	2+String(10)+1
\$49 I	Mean reticulocyte vol.	107.5	2+String(7)+1	2+String(10)+1
\$4A J	Corrected ret. count (%)	01.38	2+String(7)+1	2+String(10)+1
\$4C L	IRF	.0500	2+String(7)+1	2+String(10)+1

Table 50: CRP numerical result field list

Identifier	Correspondance	Example	All instruments (except PXL80) Format (Length)	PXL 80 Format (Length)
\$4B K	C-Reactive protein	.0600	2+String(7)+1	2+String(10)+1

Table 51: DIR numerical result fields list

Identifier	Correspondance	Example	All instruments (except PXL80) Format (Length)	PXL 80 Format (Length)
\$21 !	WBC	07.40	2+String(7)+1	2+String(10)+1
\$22 "	Lymphocytes (#)	02.03	2+String(7)+1	2+String(10)+1
\$23 #	Lymphocytes (%)	27.40	2+String(7)+1	2+String(10)+1
\$24 \$	Monocytes (#)	00.70	2+String(7)+1	2+String(10)+1
\$25 %	Monocytes (%)	09.40	2+String(7)+1	2+String(10)+1
\$28 (Neutrophils (#)	04.51	2+String(7)+1	2+String(10)+1
\$29)	Neutrophils (%)	60.90	2+String(7)+1	2+String(10)+1
\$2A *	Eosinophils (#)	00.13	2+String(7)+1	2+String(10)+1
\$2B +	Eosinophils (%)	01.70	2+String(7)+1	2+String(10)+1
\$2C ,	Basophils (#)	00.04	2+String(7)+1	2+String(10)+1
\$2D -	Basophils (%)	00.60	2+String(7)+1	2+String(10)+1
\$2E .	Atypical Lymphocytes (#)	00.11	2+String(7)+1	2+String(10)+1
\$2F /	Atypical Lymphocytes (%)	01.49	2+String(7)+1	2+String(10)+1
\$30 0	Large Immature Cells (#)	00.03	2+String(7)+1	2+String(10)+1
\$31 1	Large Immature Cells (%)	00.43	2+String(7)+1	2+String(10)+1
\$32 2	RBC	04.64	2+String(7)+1	2+String(10)+1
\$33 3	Hgb	14.17	2+String(7)+1	2+String(10)+1

Table 51: DIR numerical result fields list

Identifier	Correspondance	Example	All instruments (except PXL80) Format (Length)	PXL 80 Format (Length)
\$34 4	Hct	43.95	2+String(7)+1	2+String(10)+1
\$35 5	MCV	94.68	2+String(7)+1	2+String(10)+1
\$36 6	MCH	30.53	2+String(7)+1	2+String(10)+1
\$37 7	MCHC	32.24	2+String(7)+1	2+String(10)+1
\$38 8	RDW	12.98	2+String(7)+1	2+String(10)+1
\$3B ;	Reticulocytes (#)	0656	2+String(7)+1	2+String(10)+1
\$3C <	Reticulocytes (%)	01.41	2+String(7)+1	2+String(10)+1
\$3D =	Reticulocytes Low (%)	80.34	2+String(7)+1	2+String(10)+1
\$3E >	Reticulocytes Median (%)	14.96	2+String(7)+1	2+String(10)+1
\$3F ?	Reticulocytes High (%)	04.90	2+String(7)+1	2+String(10)+1
\$40 @	PLT	00401	2+String(7)+1	2+String(10)+1
\$41 A	MPV	07.94	2+String(7)+1	2+String(10)+1
\$42 B	THT	0.318	2+String(7)+1	2+String(10)+1
\$43 C	PDW	13.50	2+String(7)+1	2+String(10)+1
\$47 G	Retic Immatures	00.02	2+String(7)+1	2+String(10)+1
\$48 H	Mean fluorescent index (%)	17.97	2+String(7)+1	2+String(10)+1
\$49 I	Mean reticulocyte vol.	107.5	2+String(7)+1	2+String(10)+1
\$4A J	Corrected ret. count (%)	01.38	2+String(7)+1	2+String(10)+1
\$4C L	IRF	.0500	2+String(7)+1	2+String(10)+1

Table 52: PentraXL 80 manual input fields list

Identifier	Correspondance	Example	All instruments (except PXL80) Format (Length)	PXL 80 Format (Length)
\$D0	Bands (#)		2+String(7)+1	2+String(10)+1
\$D1	Bands (%)		2+String(7)+1	2+String(10)+1
\$D2	Metamyelocyte (#)		2+String(7)+1	2+String(10)+1
\$D3	Metamyelocyte (%)		2+String(7)+1	2+String(10)+1
\$D4	Myelocyte (#)		2+String(7)+1	2+String(10)+1
\$D5	Myelocyte (%)		2+String(7)+1	2+String(10)+1
\$D6	Promyelocyte (#)		2+String(7)+1	2+String(10)+1
\$D7	Promyelocyte (%)		2+String(7)+1	2+String(10)+1
\$D8	Blasts (#)		2+String(7)+1	2+String(10)+1
\$D9	Blasts (%)		2+String(7)+1	2+String(10)+1
\$DA	Others (#)		2+String(7)+1	2+String(10)+1
\$DB	Others (%)		2+String(7)+1	2+String(10)+1
\$DC	Nrbc (%)		2+String(7)+1	2+String(10)+1

Table 53: PentraXL 80 Dilution ratio management

Identifier	Correspondance	Example	Format (Length)
\$A4	WBC Parameters	1	2+String(1)+1
\$A5	RBC Parameters	1	2+String(1)+1
\$A6	Plt Parameters	1	2+String(1)+1
\$A7	DIF Parameters (same as WBC)	1	2+String(1)+1

- 1: normal dilution ratio
- 2: one half dilution ratio
- 3: one third dilution ratio
- 5: one fifth dilution ratio

Table 56: Identifier list

Identifier	Parameter	Format	Length (Pentra 120 only)	Length (all others)
\$54 T	WBC	String of characters	$2+((12(\text{max.})\times(4+1))-1)+1$	$2+(12(\text{max.})\times 4)+1$
\$55 U	RBC	String of characters	$2+((7(\text{max.})\times(4+1))-1)+1$	$2+(7(\text{max.})\times 4)+1$
\$56 V	PLT	String of characters	$2+((4(\text{max.})\times(4+1))-1)+1$	$2+(4(\text{max.})\times 4)+1$
\$69 i	RET	String of characters	$2+((2(\text{max.})\times(4+1))-1)+1$	$2+(2(\text{max.})\times 4)+1$

When there is no pathological message, length is: 2+0+1



Pentra 80/80XL Pathological messages are available in English language only.

Table 57: Pathological format description (English and other languages)

Population	Message	Signification
WBC	GRA+ or GRA-	Granulocytosis Granulopenia
	LEU+ or LEU-	Leukocytosis Leukopenia
	LYM+ or LYM-	Lymphocytosis Lymphopenia
	NEU+ or NEU-	Neutrophilia Neutropenia
	EOS+	Eosinophilia
	MYEL	Myelemia
	LIMC	Large Immature Cells
	ALYM	Atypic Lymphocytes
	LSHT	Left shift
	NRBC	Nucleated Red Blood Cells
	MON+	Monocytosis

Table 57: Pathological format description (English and other languages)

Population	Message	Signification
	BAS+	Basophilia
	BLST	Blasts
RBC	ANEM	Anemia
	ANI1 or ANI2 or ANI3	Anisocytosis level 1 Anisocytosis level 2 Anisocytosis level 3
	MIC1 or MIC2 or MIC3	Microcytes level 1 Microcytes level 2 Microcytes level 3
	MAC1 or MAC2 or MAC3	Macrocytes level 1 Macrocytes level 2 Macrocytes level 3
	MICR	Microcytosis
	MACR	Macrocytosis
	HCR1 or HCR2 or HCR3	Hypochromia level 1 Hypochromia level 2 Hypochromia level 3
	CAGG	Cold agglutinin
	ERYT	Erythrocytosis
Plt	THR+ or THR-	Thrombocytosis Thrombopenia
	PLAG	Platelet aggregates
	SCEL	Small cells
	MICC	Microcytes
	SCHI	Schizocytes
	MAPL	Macro platelet
Reticulocytes	IMMT	Immature reticulocytes

Table 57: Pathological format description (English and other languages)

Population	Message	Signification
	RET+ or RET-	Reticulocytosis Reticulopenia
All populations	????	No interpretation
	PANC	Pancytopenia

Table 58: Pathological format description (French)

Population	Messages	Signification
GB	GRA+ or GRA-	Granulocytose Granulopenie
	LEU+ or LEU-	Leucocytose Leucopénie
	LYM+ or LYM-	Lymphocytose Lymphopénie
	NEU+ or NEU-	Neutrophilie Neutropénie
	EOS+	Eosinophilie
	MYEL	Myélocémie
	GCIM	Grandes Cellules Immatures
	LYAT	Lymphocytes atypiques
	FORG	Formule gauche
	ERYB	Erythroblastes
	MON+	Monocytose
	BAS+	Basophilie
	BLST	Blastes
GR	ANEM	Anémie

Table 58: Pathological format description (French)

Population	Messages	Signification
	ANI1 or ANI2 or ANI3	Anisocytose niveau 1 Anisocytose niveau 2 Anisocytose niveau 3
	MIC1 or MIC2 or MIC3	Microcytes niveau 1 Microcytes niveau 2 Microcytes niveau 3
	MAC1 or MAC2 or MAC3	Macrocytes niveau 1 Macrocytes niveau 2 Macrocytes niveau 3
	MICR	Microcytose
	MACR	Macrocytose
	HCR1 or HCR2 or HCR3	Hypochromie niveau 1 Hypochromie niveau 2 Hypochromie niveau 3
	AGGF	Agglutinine froide
	POLY	Erythrocytose
Pla	THR+	Thrombocytose
	THR-	Thrombopenie
	AGPL	Agrégats plaquettaires
	PECL	Petits éléments cellulaires
	MICC	Microcytes
	SCHI	Schizocytes
	MAPL	Macro plaquettes
Réticulocytes	IMMT	Réticulocytes immatures
	RET+ or RET-	Réticulocytose Réticulopénie
Toutes populations	????	Pas d'interprétation possible
	PANC	Pancytopenie



5.2.4. Histograms

5.2.4.1. Histograms

Histograms are transmitted on 128 channels, preceded by a space. They are automatically rescaled to a 223 maximum amplitude value. The zero amplitude value is \$20, the maximum amplitude value is \$FF.

Extended format:

The extended format includes all the height informations relative to each channel. It is constituted by a chart of 256 [RES] entries of 16 bits each. These 512bytes chart is encoded before being transmitted. The format is as follow: identifier, space, encoding type on 8 characters (od or uencode), space, encoded data size on 5 characters, space, data then carriage return.

5.2.4.2. Separation thresholds

It is the channel number (decimal value) enclosing areas on the histograms or on the matrix. Each threshold is transmitted on 3 bytes preceded by a space. Format description of the threshold transmission

A. WBC identifier

Separation thresholds 1-2-3 allow the L1 flag determination. For the analyzers in LMG mode, the 4-5 thresholds allow the separation of the 3 populations Lymphocytes, Monocytes, Granulocytes.

Example 1: output format of the WBC curve thresholds for an LMG sampling. In this example, the analyzer doesn't send the calculation thresholds of the L1 flag.
«] 000 000 000 040 060» + carriage return.

Example 2: output format of the WBC curve thresholds for CBC and DIFF sampling. In this 5parts DIFF analyzer, the LMG is not measured, the 4-5 thresholds are not significant.

«] 005 008 020 000 000» + carriage return.

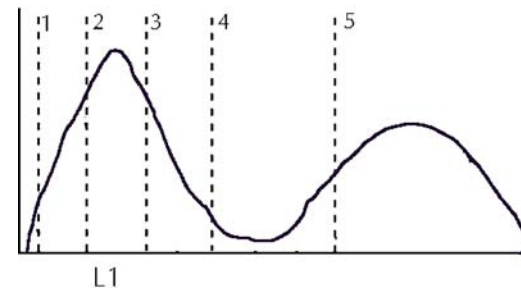

Diag.2: WBC thresholds

B. RBC identifier

Separation thresholds 1-2 allow the calculation of the microcytic and macrocytic cell proportions.

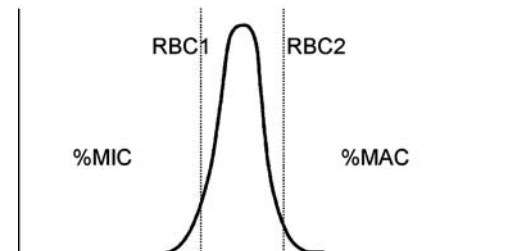

Diag.3: RBC histogram

C. PLT identifier

The threshold 1 is the number of the last channel used to calculate the PLT number.



Diag.4: Plt histogram

D. Basophil identifier

Thresholds 1-2-3 allow the determination of the basophil proportion regarding the total number of WBCs.

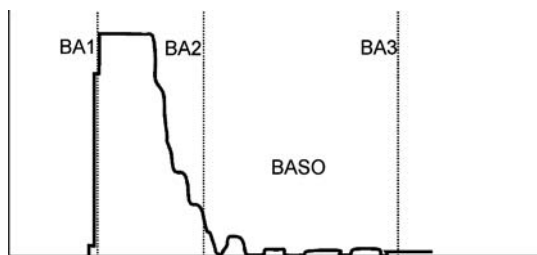

Diag.5: BASO histogram

5.2.5. Matrix

Screen bitmap: 2048 graphic bytes matrix are transmitted on 4096 ASCII bytes, preceded by a space. Each group of 2 ASCII bytes is the value of 1 graphic byte represented from the left to the right and from the top to the bottom of the screen (principles of the recovery of the 128x16 matrix bitmap on the PENTRA 120 LCD board). The double matrix [127 (ABS) x 256 (RES)] is transmitted according to the same

procedure.

Extended mode format (3D curve): The extended format includes all the height informations relative to each channel. It is constituted by a chart of 128 [ABS] x 128 [RES], 128 [ABS] x 256 [RES] or 256 [OFL] x 128Extended mode format (3D curve): The extended format includes all the height informations relative to [CIS] entries of 16 bytes each. These 32K or 64K charts are first of all compressed (3k approximately for a 32K chart) then encoded (expansion 1 to 2) before being transmitted. The format is as follow: identifier, space, compression algorithm on 8 characters ("compress" or "gzip" or "lha" or "squeeze"), space, encoding type on 8 characters (od or uencode), chart format on 8 characters, space, encoded data size on 5 characters, space, data then carriage return.

Example: \$6C \$20 uencode \$20 00724 \$20 data \$0D

Examples:

\$64 \$20 lha\$20\$20\$20\$20\$20 \$20od\$20\$20\$20\$20\$20\$20 \$20 128Y256X \$20 10772 \$20 data \$0D

\$65 \$20 compress \$20 uencode \$20128X128Y \$20 05386 \$20 data \$0D

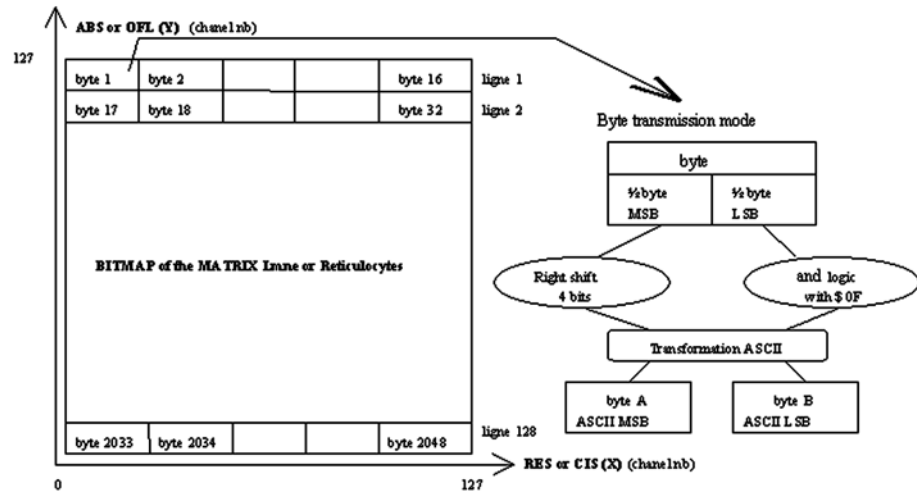

Diag.6: Matrix transmission

A. Lmne matrix identifier

The 12 resistive thresholds are transmitted in the following order: NoL, NoN, NoE, LN, RN, LL, AL, LMU, LMD, LMN, MN, RM. The 3 absorbance thresholds are following: NL, NE, RMN.

At the end the width of the areas (in channel number) describing the proximity flags : FNE, FMN, FLN are transmitted.

Areas surrounded by bolt lines give the matrix populations. Names of the populations are shown in *italic*.

Hatched areas give the sub populations and belong to the main population.

Framed items are the proximity flags. Surrounded items are inflexion points similar to separation thresholds.

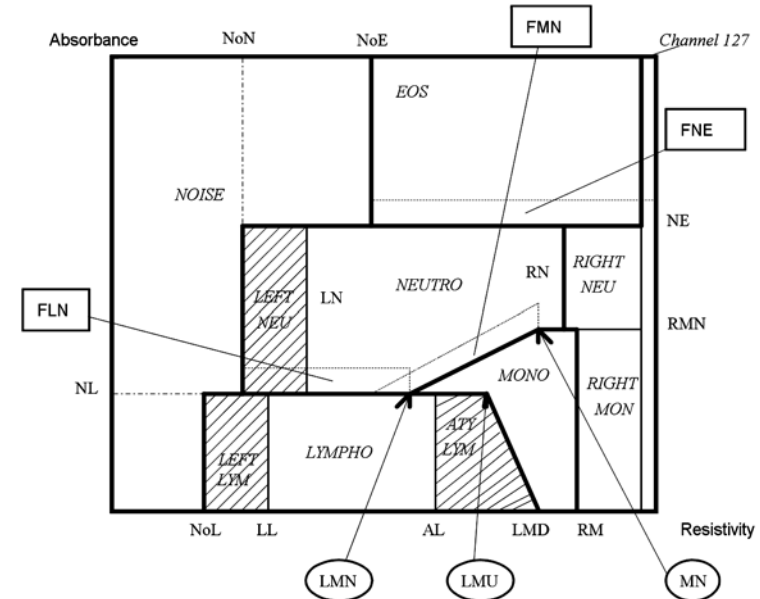

Diag.7: English Lmne matrix identifiers

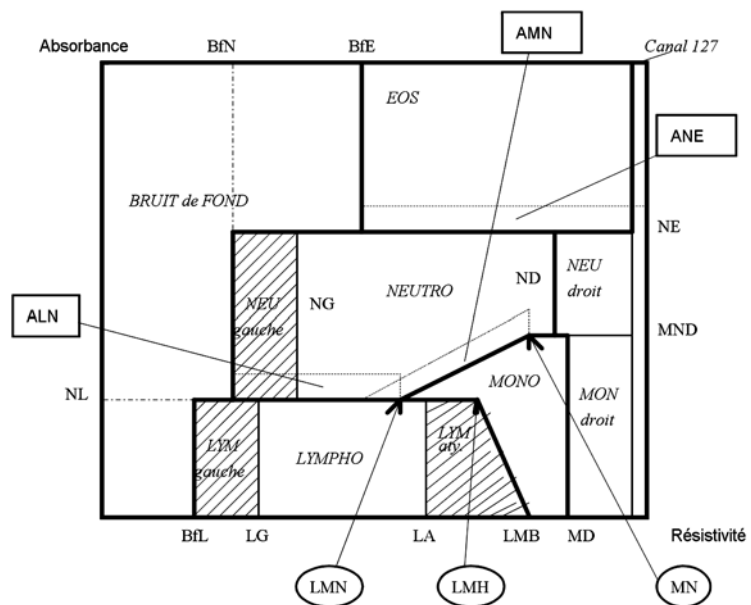

Diag.8: French Lmne matrix identifiers

B. Reticulocyte matrix identifier

The 4 resistive thresholds are transmitted in the following order: R1, R2, R3, R4. Then the 4 fluorescent thresholds are following: F1, F2, F3, F4.

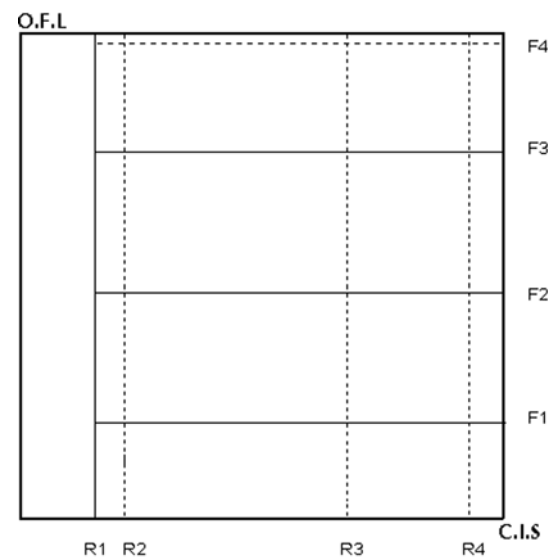

Diag.9: Reticulocyte matrix identifier

Table 59: Histogram & Matrix format description

Identifier	Parameter	Format	Length
\$57 W	WBC	Amplitude of each channel	2+128+1
\$58 X	RBC	Amplitude of each channel	2+128+1
\$59 Y	Pit	Amplitude of each channel	2+128+1
\$5A Z	Basophils	Amplitude of each channel	2+128+1
\$5B [Lmne matrix	Screen bitmap	2+4096+1
\$5C \	Reticulocyte matrix	Screen bitmap	2+4096+1
\$5D]	WBC thresholds	5 thresholds	1+20+1

Table 59: Histogram & Matrix format description

Identifier	Parameter	Format	Length
\$5E ^	RBC thresholds	2 thresholds	1+8+1
\$5F _	PLT thresholds	1 threshold	1+4+1
\$60 ‘	Basophil thresholds	3 thresholds	1+12+1
\$61 a	Lmne matrix thresholds	12 RES thresholds, 6 ABS thresholds (3 of them give the proximity flags: FLN, FMN, FNE)	1+72+1
\$62 b	Reticulocyte matrix thresholds	4 CIS thresholds, 4 OFL thresholds	1+32+1
\$63 c	Double matrix Lmne	screen bitmap	2+8192+1
\$64 d	Lmne matrix	extended format	see description
\$65 e	Reticulocyte matrix	extended format	see description
\$6C l	WBC	extended format	see description
\$6D m	RBC	extended format	see description
\$6E n	PLT	extended format	see description
\$6F o	BASO	extended format	see description

5.2.6. Other identifiers

Identifier \$FB: Identifies the analyzer type when communicating.

Identifier \$FC: This identifier allows the transmission of a number which can be an error number, a position number, a burn-in sequence number or a status in hexadecimal mode (Not available yet).

Identifier \$FD: Checksum value (see section on the message structure).

Identifier \$FE: The version number is linked to the development of the hematological message identifiers.



Identifier \$FC: The error list is dedicated to the "remote" mode, however the MICROS instrument is able to transmit the error #0001 (Operating temperature out of limits).

For \$FB and \$FF, the strings having less than 8 characters are completed on the

right handside by "spaces".

Table 60: Other identifiers

Identifier	Correspondance	Format	Length
\$A3	Pentra 80XL: Report state	V: Validated R: Rejected U: Unvalidated	2+1+1
\$FB	Analyzer name	Character string	2+8+1
\$FC	Number	8 decimal bytes	2+8+1
\$FD	16 bits check sum value	4 hexadecimal bytes	2+4+1
\$FE	Version N° of Identifier list	String of characters: Vx.xx	2+5+1

Table 61: \$FB Analyzer name

Identifier	Name (8 chracters)
\$FB	ABC60
	ADVIA60
	MICROS45
	MICROS60
	MICROS2D
	HELIOS
	ARGOS
	VEGA
	PENTRA60
	PENTRA80



6. Query mode

6.1. Sending orders

Requests send by the host when line is free.

Query mode:

- This optional mode allows the Host to selectively load the working list of each sample, once the barcode of the sample has been read and a Query request is emitted by the instruments.
- This mode is of particular interest when the Host system manages several instruments analysers. In this case, the Query request transmitted by one of the analysers allows the Host system to load the working list on the instrument identified by the presence of the sample on this analyzer.
- The Query request is a 'FILE' type message and encapsulates 1 or several blocks surrounded by STX & ETX including the '\$75' type line followed by the identification of the sample (barcodes) (Maximum 10 Blocks per Query request).
- Transmission of the Query requests is carried out by instrument immediately after the tray of 10 samples has been read. Only the samples identified by a barcode, and for which instrument did not receive a working list will be transmitted in the QUERY request.
- The Host system has an answering delay which is adjustable on the analyzer (25 seconds by default). This delay is fixed after transmission of the last Query message, in order to return the message to load the working list of the sample or the samples concerned. Once the delay has been respected and in the case where no message is received by the analyzer, the rack of samples is automatically discharged without carrying out tests.
- The adjustment of the answering delay of the Host system is ideally fixed at 25 seconds by default. It is possible to change the value of this parameter, however, from 30 seconds on the analyser generates a supplementary waiting cycle of 30 seconds, or 2 waiting cycles from 60 seconds, involving a reduction of the analytical output capacity.

Table 62: QUERY request line structure

Identifier	Correspondance	Format	Length
\$FF y	Data Packet	Character string	2+8+1
\$75 u	Identification #	Character string	2+16+1

Loading protocol of a working list in answer to a QUERY request:

Table 63: Instrument transmits to the Host a QUERY request

Flow	Dataflow	Comments
Instrument>Host	\$01	Pentra sends SOH
Host>Instrument	\$05	Host responds ENQ
Instrument>Host	\$02\$FF FILE \$OD \$75 123456789012 \$OD \$03	Pentra sends STX + First Query Message + ETX
Host>Instrument	\$06	Host responds ACK
Instrument>Host	Pentra sends STX + Next Query Message + ETX
Host>Instrument	\$06	Host responds ACK
Instrument>Host	Pentra sends STX + Last Query Message + ETX
Host>Instrument	\$06	Host responds ACK
Instrument>Host	\$02 00043\$OD \$FF END \$OD \$03	Pentra sends STX + Free line + ETX
Host>Instrument	\$06	Host responds ACK

Once the Host receives a Query type message, it returns a message to load the working list for the sample or samples concerned, respecting the delay programmed on the instrument (25 seconds by default).



6.2. Resampling and reflex testing

- This optional mode offers the possibility to the Host system of returning the re-sampling request to the analyser, according to a decision algorithm calculated by the Host system and in answer to an analytical result transmitted by the analyser.
- The request of re-sampling allows for the carrying out of the same tests as those requested during the former sampling procedure, or any other test amongst those available. It is therefore possible for example to carry out a request for complementary tests during the re-sampling procedure.
- When the remote controlled re-sampling mode is activated and after transmission of each result the analyser waits for the re-sampling decision message from the Host system. Whatever decision is taken by the Host system, it returns a message, either a re-sampling request, or when the result obtained does not require re-sampling the freeing of the blood sample without re-sampling.
- The Host system has an answering delay which is adjustable on the analyser (25 seconds by default). This delay is fixed after transmission of the last result in order to return the re-sampling request or the message to free the sample. Once the delay has been respected and in the case where no message is received by the analyser, the rack of samples is automatically discharged without re-sampling .
- The adjustment of the answering delay of the Host system is ideally fixed at 25 seconds by default. It is possible to change the value of this parameter, however, from 30 seconds on the analyser generates a supplementary waiting cycle of 30 seconds, or 2 waiting cycles from 60 seconds involving consequently a reduction of the analytical output capacity.

Table 64: Structure of lines included in the message «re-sampling request»

Identifier	Correspondance	Format	Length
\$FF ÿ	Data Packet	Character string	2+8+1
\$75 u	Identification	Character string	2+16+1
\$80 Ç	Analysis type	Defined on 1 character See Note 13	2+1+1

Table 65: Structure of lines included in the message «end of re-sampling»

Identifier	Correspondance	Format	Length
\$FF ÿ	Data Packet	Character string	2+8+1
\$75 u	Identification	Character string	2+16+1
\$80 Ç	Analysis type	'@'	2+1+1

Table 66: Transmission of results protocol and insertion of automatic re-sampling

Flow	Dataflow	Comments
Instrument>Host	\$01	Pentra sends SOH
Host>Instrument	\$05	Host responds ENQ
Instrument>Host	\$0205395\$OD \$FF RESULT \$OD \$03	Pentra sends STX + Result + ETX

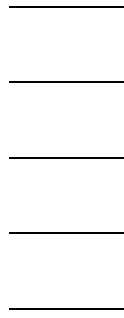
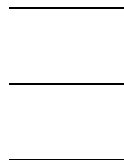

Table 66: Transmission of results protocol and insertion of automatic re-sampling

Flow	Dataflow	Comments
Host>Instrument	\$06	Host responds ACK
Instrument>Host	\$02 00043\$OD \$FF END \$OD \$03	Pentra sends STX + Free line + ETX
Host>Instrument	\$06	Host responds ACK





Once the line has been freed the Host returns a re-sampling message in a delay of <25s ideally...

Table 67: Host sends «re-sampling message»

Flow	Dataflow	Comments
Host>Instrument	\$01	Host sends SOH
Instrument>Host	\$05	Pentra responds ENQ
Host>Instrument	\$02\$FF FILE \$OD \$75 123456789012 \$80 B \$OD \$03	Host sends STX + ReRun + ETX
Instrument>Host	\$06	Pentra responds ACK
Host>Instrument	\$02 00043\$OD \$FF END \$OD \$03	Host sends STX + Free line + ETX
Instrument>Host	\$06	Pentra responds ACK

...or the Host returns a message «end of re-sampling»

Table 68: Host sends «end of re-sampling»

Flow	Dataflow	Comments
Host>Instrument	\$01	Host sends SOH
Instrument>Host	\$05	Pentra responds ENQ
Host>Instrument	\$02\$FF FILE \$OD \$75 123456789012 \$80 @ \$OD \$03	Host sends STX + No more RerRun + ETX

Table 68: Host sends «end of re-sampling»

Flow	Dataflow	Comments
Instrument>Host	\$06	Pentra responds ACK
Host>Instrument	\$02 00043\$OD \$FF END \$OD \$03	Host sends STX + Free line + ETX
Instrument>Host	\$06	Pentra responds ACK



Chapter 5

ARGOS Format



ARGOS Format

ASTM Format is recommended by ABX Diagnostics for every new connection development. Argos Format is not supported on new system generation.

1. Introduction

The ARGOS format is a fixed format included between STX and ETX. These characters are splitted into fields representing a transmitted item.

STX	DATA	CRC	ETX
-----	------	-----	-----

The data transmitted can be a result:

STX	«R» / ANALYSER # / N°ID / ID / etc..	CRC	ETX
-----	--------------------------------------	-----	-----

or a patient file:

STX	«D» / ANALYSER # / N°ID / ID / etc..	CRC	ETX
-----	--------------------------------------	-----	-----

or end of communication:

STX	«E» / ANALYSER # / etc..	CRC	ETX
-----	--------------------------	-----	-----

The fields have a fixed length separated by the \$0D character.

2. Protocol description

2.1. Typical transmission from Host to Instrument

Table 69: Typical transmission from Host to Instrument

Host	<>	Instrument	Comment
<SOH>	>		Host take the Line
	<	<ENQ>	
<STX> + FILE + <ETX>	>		
	<	<ACK>	
	.		
	.		
	.		
<STX> + END + <ETX>	>		Host free the Line
	<	<ACK>	

2.2. Typical transmission from Instrument to Host

Table 70: Typical transmission from Instrument to Host

Instrument	<>	Host	Comment
<SOH>	>		instrument take the Line
	<	<ENQ>	
<STX> + RESULT + <ETX>	>		
	<	<ACK>	
	.		
	.		



Table 70: Typical transmission from Instrument to Host

Instrument	<>	Host	Comment
	.		
<STX> + END + <ETX>	>		instrument free the Line
	<	<ACK>	

3. Results characteristics

3.1. Key

Total ASCII characters emitted: 406

- (-) : Space \$20
- (␣) : Carriage return \$0D
- CRC : exclusive "OR" of all the transmitted bytes except ETX and STX, then an inclusive "OR" with a \$40 value.
- zzzzz : numeric field completed by zeros on the left.
ex : 04.55 (decimal separation with a period).
- When the analyser does not transmit parameters, the field (zzzzz) is put in place of (--.--).
- Y : Alphanumeric character from \$20 to \$7F.
- # : Space (\$20) if automatic sampling. Star (\$2A) if manual sampling.

Table 71: Line free format first digit (R: Reject)

First digit (letter)	Correspondance
R	Parameter rejected for a counting default
B	Incorrect balance between the counting methods
S	Suspicious parameter value
'space'	No anomaly observed

Table 72: Line free format second digit (N: Normalities)

Second digit (letter)	Correspondance
L	Parameter < to the lower extreme value
I	Parameter < to the low normal value
'space'	Parameter normal value
h	Parameter > to the high normal value
H	Parameter > to the high extreme value
O	Parameter exceeding the capacity

3.2. Result format

Table 73: Result format

Line	Data	Comment	Length
Line 1	STX (\$02)	Start of text	1
	R (\$44)	Character «R»	1
	zz]	Analyser No	2 + 1
Line 2	YYYYYYYYYYYYYYYYY]	Identification No	16 + 1
Line 3	YYYYYYYYYYYYYYYYYYYYYYYYYYYYYYYYY]	Identification	30 + 1
Line 4	zz/zz/zz-zzhzzmnzsz#]	Time & Date	20 + 1
Line 5	zzzzz-RN]	WBC	8 + 1
Line 6	zzzzz-RN]	LYM#	8 + 1
Line 7	zzzzz-RN]	LYM%	8 + 1
Line 8	zzzzz-RN]	MON#	8 + 1
Line 9	zzzzz-RN]	MON%	8 + 1
Line 10	zzzzz-RN]	GRA#	8 + 1



Table 73: Result format

Line	Data	Comment	Length
Line 11	zzzzz-RN]	GRA%	8 + 1
Line 12	zzzzz-RN]	NEU#	8 + 1
Line 13	zzzzz-RN]	NEU%	8 + 1
Line 14	zzzzz-RN]	EOS#	8 + 1
Line 15	zzzzz-RN]	EOS%	8 + 1
Line 16	zzzzz-RN]	BAS#	8 + 1
Line 17	zzzzz-RN]	BAS%	8 + 1
Line 18	zzzzz-RN]	ALY#	8 + 1
Line 19	zzzzz-RN]	ALY%	8 + 1
Line 20	zzzzz-RN]	LIC#	8 + 1
Line 21	zzzzz-RN]	LIC%	8 + 1
Line 22	zzzzz-RN]	RET parameter	8 + 1
Line 23	zzzzz-RN]	RET parameter	8 + 1
Line 24	zzzzz-RN]	RET parameter	8 + 1
Line 25	zzzzz-RN]	RET parameter	8 + 1
Line 26	zzzzz-RN]	RBC	8 + 1
Line 27	zzzzz-RN]	HGB	8 + 1
Line 28	zzzzz-RN]	HCT	8 + 1
Line 29	zzzzz-RN]	MCV	8 + 1
Line 30	zzzzz-RN]	MCH	8 + 1
Line 31	zzzzz-RN]	MCHC	8 + 1
Line 32	zzzzz-RN]	RDW	8 + 1
Line 33	zzzzz-RN]	RET parameter	8 + 1
Line 34	zzzzz-RN]	PLT	8 + 1
Line 35	zzzzz-RN]	MPV	8 + 1
Line 36	zzzzz-RN]	PCT	8 + 1

Table 73: Result format

Line	Data	Comment	Length
Line 37	zzzzz-RN]	PDW	8 + 1
Line 38	ABCDEFGHIJKLMNQRSTU]	WBC 5DIFF flags	21 + 1
Line 39	LMMGGG]	WBC LMG Flag	6 + 1
Line 40	PSM]	Plt Flags	3 + 1
Line 41	CRC		1
Line 42	ETX (\$03)	end of text	1
		Total:	406

Table 74: WBC 5DIFF Flags (Line 38)

Character	French	English
A	Lg	LL
B	Ln	NL
C	Mn	MN
D	Ng	LN
E	Md	RM
F	Nd	RN
G	No	NO
H	Co	CO
I	Ne	NE
J	X2	X2
K	X3	X3
L	MP	MP
M	LOW	LOW
N	LAS	LAS
O	PIT	PIT
P	Mb	MB
Q	FIT	FIT