

OUTPUT FORMATS

ABX **Pentra ML**

RAA026FEN

Table of Contents

-> "See ASTM Format description", page 3

-> "See ABX Format", page 20



ASTM Format description

HORIBA Medical ABX Pentra ML format responds to the ASTM specifications E-1381 & E-1394:

- E-1381: Standard specification for Low Level protocol to transfer messages between clinical and laboratory instrument and computer systems.
- E-1394: Standard specification for transferring Information between clinical and laboratory instruments and computer systems.

The ASTM LIS feature of the ABX Pentra ML Data Management software allows an external LIS to communicate with one or more ABX Pentra ML Data Management through one LIS serial line. This document is intended as a guide to LIS vendors developing interfaces that communicate with the ABX Pentra ML Data Management System.

Table 1: Definitions

Term	Definition
<ACK>	Acknowledgment (ASCII Decimal 6)
[C1]	The most significant character of Checksum
[C2]	The least significant character of Checksum
[DATA]	The data contents of the record
<ENQ>	Inquire (ASCII Decimal 5)
<ETB>	End of Transmission Block (ASCII Decimal 23). For use only when a single record is too large to fit into one frame.
<ETX>	End of Text (ASCII Decimal 3). Required at the end of each record.
[frame number]	Single digit frame number "0" to "7", starts with "1".
<LF>	Line Feed (ASCII Decimal 10).
<NAK>	Negative Acknowledgment (ASCII Decimal 21).
<STX>	Start of Frame (ASCII Decimal 2).
Communication packet	All framing required for transmission of data. This framing includes: <STX>[frame number][DATA] [<ETB> or <ETX>][C1][C2] <LF>
Component Field	One of several related pieces of information within a field.
Download	The transmission of data from the LIS to the ABX Pentra DX Data Management System.

Table 1: Definitions

Term	Definition
Field	A specific location within a record for a piece of information indicated by a field delimiter and position.
Frame	A complete communications packet.
LIS	Laboratory Information System
Message	A collection of related information; a group of records that begins with a «Header» record and ends with a «Terminator» record. A single record could theoretically constitute a message, but within this context, a message always contains multiple records.
Receiver	The device that responds to the sender. The receiver in this document is either the ABX Pentra DX Data Management System or the LIS.
<EOT>	End of Transmission (ASCII decimal 4)
<CR>	Carriage Return (ASCII decimal 13)
Record	In reference to the low level protocol, a record is the message data (shown as [DATA]) as described within the communications packet. If the data is longer than 240 characters, then it must be split into two (or more) parts and sent in two (or more) communications packets. The intermediate packet uses the <ETB> character, and the ending packet uses the <ETX> character. No single communications packet contains more than one record. In reference to the message layer, a record can be one of the following codes: H (header), P (patient), O (order), R (result), L (terminator), C (comment).
Repeat Field	An additional field of the preceding type when indicated by a repeat delimiter. The ABX Pentra DX Data Management System parses and may produce repeat fields in the Universal Test ID field of a Test Order Record or the Value field of the Result Record, but ignores other occurrences of repeat fields.
Sender	The device that has a message to send and initiate the transmission process, in this case between the LIS and the ABX Pentra DX Data Management System. The sender in this document is either the ABX Pentra DX Data Management System or the LIS.
Session	A total unit of communication activity used in this standard to indicate the events starting with the Establishment phase and ending with the Termination phase.
Test	A determination of a single analyte or a combination of values from other determinations or observations from which a variable or gradable result is derived.
Upload	The transmission of data from the ABX Pentra DX Data Management System to the LIS.



1. Connection

All communications are expected to use either the RS232 communication protocol, (based upon the Electronics Industries Association (EIA) standard RS232-C) or the TCP/IP protocol. As part of the conformance to this standard, the ABX Pentra ML Data Management System is configured as Data Terminal Equipment (DTE).

1.1. Serial (RS232)

The ABX Pentra ML Data Management System is cabled to the LIS via a DB-9 connector on the octopus cable plugged into the computer workstation on the ABX Pentra ML.

Table 2: DB9 Connection

Pin (DB9) ABX Pentra ML Data Management	LIS Port Configuration (ABX Pentra ML)	LIS Cable Must Provide
3	RXD	TXD
2	TXD	RXD
5	Ground	Ground

Physical layer:

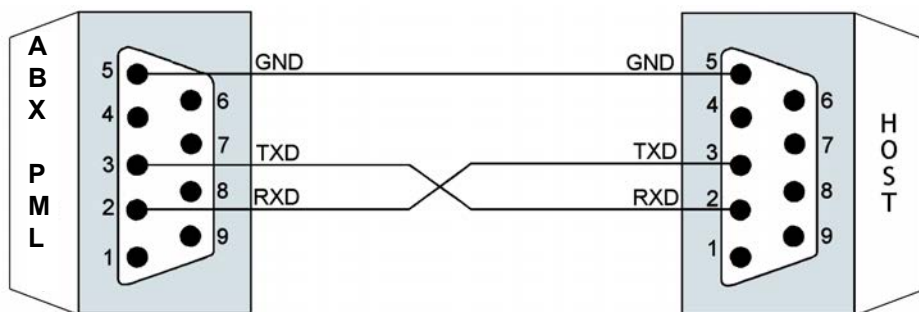

1.2. Ethernet

1.2.1. FTP mode

ABX Pentra ML starts connection with FTP server just before it sends the file, then it is disconnected. A file per sample ID is created. The host only has to be set as a server. The ABX Pentra ML being the client.

Directories selected for download (ordering) and upload (results) must be different. Ordering folder («prog») content is scanned by ABX Pentra ML regularly (frequency can be set up in the application).

Naming convention:

Generated results: <prefix>YYYYMMDDHHmmssxxx.<extension> (xxx=ms)
Ordering: according to FTP configuration

1.2.2. TCP Mode

Host TCP socket must be setup with (Host is always server):

- Port number where ABX Pentra ML is connected

ABX Pentra ML TCP socket must be setup with (ABX Pentra ML is always client):

- Host IP address or DNS address
- the Port number where Host is awaiting connection

The data format is according to ASTM protocol.

2. Output data characteristics

Table 3: ABX Pentra ML analysis types

Analysis type
Receive Orders
Query
CBC
DIF
RET
ERB
CBR
DIR
CBE

Allowed characters: Allowed are ASCII 10 (LF), 13 (CR), 32-126, 128-254. However, the message data sent to the ABX Pentra ML Data Management System must be restricted to ASCII 32-126 for proper operation of the ABX Pentra ML Data Management System Software. Specific fields may further restrict allowed characters.
Maximum message length: 240 characters.

2.1. Communication protocol

Table 4: Standard control characters

Control String	Hexadecimal value
<ENQ>	\$05
<ACK>	\$06
<NAK>	\$15
<STX>	\$02
<ETX>	\$03

Table 4: Standard control characters

Control String	Hexadecimal value
<CR>	\$0D
<LF>	\$0A
<EOT>	\$04

2.2. ASTM Data frame format

A sequential number located after the <STX> character is inserted into each Data frame. Frame number is set to 1 when transfer phase is initialized and is incremented by 1 for each frame up to 7 and then returns to 0.

Frame number is to permit receiver to distinguish between new and retransmitted frame, in case of retransmitted frame (after a <NAK> response from Host), frame number is not incremented: <STX>1...Data...<CR><ETX>[C1][C2]<CR><LF>

Table 5: Frame format

ASTM field	Definition	Transmitted data	# of bytes	Comments
0	<STX>	\$02	1	
1	Frame number	1 to 7, 0, ...	1	Frame number is set to 1 and incremented by 1 for each frame up to 7 and then returns to 0
2	Data message		240 max.	Header, Patient, Order, Result & Comment messages
3	End of data message <ETX> if end frame		1	
4	Checksum		2	
5	<CR><LF>	\$0D \$0A	2	

2.2.1. ABX Pentra ML\Host connexion

Table 6: Typical discussion between ABX Pentra ML and LIS

ABX Pentra ML	< >	LIS
<ENQ>	>	
	<	<ACK>
<STX>1...Data...<CR><ETX>[C1][C2]<CR><LF>	>	
	<	<ACK>
<STX>2...Data...<CR><ETX>[C1][C2]<CR><LF>	>	
	<	<ACK>
<EOT>	>	

Table 7: Typical discussion between LIS and ABX Pentra ML

ABX Pentra ML	< >	LIS
	<	<ENQ>
<ACK>	>	
	<	<STX>1...Data...<CR><ETX>[C1][C2]<CR><LF>
<ACK>	>	
	<	<STX>2...Data...<CR><ETX>[C1][C2]<CR><LF>
<ACK>	>	
	<	<EOT>

2.2.2. Discussion with conflict between ABX Pentra ML and Host

If negative answer (NAK): ABX Pentra ML sends again the same frame, up to 6 times.
 If there is no response to an ENQ, another ENQ is sent 18s after.
 In case of ENQ\ENQ conflict, ABX Pentra ML waits for 5s and sends <ACK>.
 ABX Pentra ML is master in case of conflict.

2.2.3. Defect packet during discussion between ABX Pentra ML and Host

Table 8: Defect packet during discussion between ABX Pentra ML and Host

ABX Pentra ML	< >	Host
<ENQ>	>	
	<	<ACK>
<STX>1...Data...<CR><ETX>[C1][C2]<CR><LF>	>	
	<	<NAK>
<STX>1...Data...<CR><ETX>[C1][C2]<CR><LF>	>	
	<	<ACK>
<STX>2...Data...<CR><ETX>[C1][C2]<CR><LF>	>	
	<	<ACK>
<EOT>	>	

2.2.4. Frame checksum

According to ASTM E-1381 frame checksum (<STX>1...Data...<CR><ETX>[C1][C2]<CR><LF>) is defined as modulo 256 of ASCII values sum between <STX> not included and <ETX> included characters: 1...Data...<CR><ETX>



3. Records general format specifications (ASTM E-1394)

Data frames encapsulate Records defined by ASTM E-1394 norm, Records themselves encapsulate ATSM fields.

Example of record inside Data frame: <STX>1...Data...<CR><ETX>[C1][C2]<CR><LF>
<STX>1H|^&||||HostSimulator|||||ABX||P|E1394-
97|20020705144108<CR><ETX>D3<CR><LF>

Table 9: ASTM Records

Record ID	ASTM Definition
H	Header
P	Patient
O	Order
R	Result
C	Comment
Q	Query (Request information order)
L	Terminator record

3.1. Structure of Records

3.1.1. Structure of records for Order transmission

- H (Header)
- .P (Patient)
- .C (Patient Comments) Optional
-O (Order)
-C (Order Comments) Optional
- L (Terminator)

The transmission of an Order without Patient record is not allowed, but Patient record can be empty. Example: <STX>2P|1<CR><ETX>BB<CR><LF>

3.1.2. ABX Pentra ML Patient file modification by Host

- H (Header)
- .P (Patient)
- .C (Patient Comments) Optional
- L (Terminator)

3.1.3. Structure of records for Result transmission

- H (Header)
- .P (Patient)
- .C (Patient Comments) Optional
-O (Order)
-C (Order Comments) Optional
-C (Run Alarms) Optional
- R (Result)
- C (Flag Result) Optional
- R (Result)
- C (Flag Result) Optional
-
-
- R (Result)
- C (Flag Result) Optional
- L (Terminator)

3.2. Description of Records

- Only the fields described with their specified length, in further tables, are used by HORIBA Medical ABX Pentra MLs.
- Length of field can be less than maximum value but must not be more.
- Only «Sample ID» and «Test» fields from Order record must be informed, all other fields are optionals.
- Delimiter must be used even if field is free.
- Delimiters inside records are separate by «|» (ASCII \$7C).
- Delimiters inside fields are separate by «^» (ASCII \$5E).



3.2.1. Header record

Table 10: Header record fields

ASTM field	Definition	Transmitted data	Field max. length	PML Receives	PML Sends
7.1.1	Record Type	H	1	Required	Required
7.1.2	Delimiters definition	idem standard: Field delimiter \ Repeat delimiter ^ Component delimiter & Escape delimiter	4	Required	Required
7.1.3	Message Control ID			Ignored	No
7.1.4	Access Password			Ignored	No
7.1.5	Sender Name	PML	3	Ignored	Yes
7.1.6	Sender Address			Ignored	No
7.1.7	Reserved field			Ignored	No
7.1.8	Sender Telephone Nb			Ignored	No
7.1.9	Characteristics of Sender			Ignored	No
7.1.10	Receiver ID			Ignored	No
7.1.11	Comments or Special Instructions			Ignored	No
7.1.12	Processing ID	P	1	Ignored	Yes Always 'P'
7.1.13	ASTM Version Nb	1394-97	12	Ignored	Yes
7.1.14	Date and Time of message	YYYYMMDDHHMMSS	14	Ignored	Yes current

3.2.2. Patient record

Table 11: Patient record fields

ASTM field	Definition	Transmitted data	Field max. length	PML Receives	PML Sends
8.1.1	Record Type	P	1	Required	Required
8.1.2	Sequence Nb	1, 2, ...	3	Required	Required
8.1.3	Practice Assigned Patient ID			Ignored	No
8.1.4	Laboratory Assigned Patient ID	Patient Id	25	Required	Yes
8.1.5	Patient ID No 3			Ignored	No
8.1.6	Patient Name	Lastname^Firstname	20^20	Yes	Yes
8.1.7	Mother's Maiden Name			Ignored	No
8.1.8	Birthdate	YYYYMMDD^NNN^A See Note 1	8^3^1	Yes	Yes
8.1.9	Patient Sex	M: Male F: Female All other values are treated as Unspecified	1	Yes	Yes
8.1.10	Patient Race-Ethnic Origin			Ignored	No
8.1.11	Patient Address			Ignored	No
8.1.12	Reserved field			Ignored	No
8.1.13	Patient Telephone Nb			Ignored	No
8.1.14	Attending Physician ID	Text	20	Yes	Yes
8.1.15	Special Field 1	Specy See Note 2		Yes	No
8.1.16	Special Field 2	Specy See Note 2		Yes	No
8.1.17	Patient Height			Ignored	No
8.1.18	Patient Weight			Ignored	No
8.1.19	Patient's Known or Suspected Diagnosis			Ignored	No
8.1.20	Patient Active Medication			Ignored	No
8.1.21	Patient's Diet			Ignored	No
8.1.22	Practice Field 1			Ignored	No



Table 11: Patient record fields

ASTM field	Definition	Transmitted data	Field max. length	PML Receives	PML Sends
8.1.23	Practice Field 2	Specy See Note 2		Yes	No
8.1.24	Admission and Discharge Dates			Ignored	No
8.1.25	Admission Status			Ignored	No
8.1.26	Location	Text	20	Yes	Yes
8.1.27	Nature of Alternative Diagnostic Code and Classifiers			Ignored	No
8.1.28	Alternative Diagnostic Code and Classifiers			Ignored	no
8.1.29	Patient Religion			Ignored	No
8.1.30	Martial status			Ignored	No
8.1.31	Isolation Status			Ignored	No
8.1.32	Language			Ignored	No
8.1.33	Hospital Service			Ignored	No
8.1.34	Hopital Institution			Ignored	No
8.1.35	Dosage Category			Ignored	No



• **NOTE 1:** 8.1.8 «Birthdate»: If the birthdate is sent by the LIS, the age and age unit fields are ignored and recalculated at the ABX Pentra ML Data Management. If no birthdate is sent, then the age and age unit fields are used:

Format sent is ^NNN^A

NNN: Age

A: Age unit 'Y': Year, 'M': Month, 'D': Day

• **NOTE 2:** Specy is indicated in one of the following fields, according to ABX Pentra ML configuration (in *pentradx.ini* file) :

- 8.1.15 or 8.1.16 (Special Field 1/2)
- 8.1.23 (Practice Field 2)
- 9.4.16 (Specimen Descriptor)
- 9.4.19 or 9.4.20 (User Field 1/2)
- 9.4.21 or 9.4.22 (Laboratory Field 1/2)

3.2.3. Order record

Table 12: Order record fields

ASTM field	Definition	Transmitted data	Field max. length	PML Receives	PML Sends
9.4.1	Record Type	O	1	Required	Required
9.4.2	Sequence Nb	1, 2, ...	3	Required	Required
9.4.3	Sample ID	SampleID^Rack^Position See Note 3	16^3^2	SampleID Required	Required
9.4.4	Instrument Specimen ID			Ignored	No
9.4.5	Universal Test ID	^^^Test name See Note 4		Required	Yes
9.4.6	Priority	S: Stat mode (Priority) All other priority code are treated as «Routine» mode	1	Yes	Yes
9.4.7	Requested/Ordered Date and Time			Ignored	No
9.4.8	Specimen Collection Date and Time	YYYYMMDDHHMMSS See Note 5	14	No	Yes
9.4.9	Collection End Time			Ignored	No
9.4.10	Collection Volume			Ignored	No
9.4.11	Collector ID			Ignored	No
9.4.12	Action Code	A or N: Create order Q: Control	1	Ignored (Except A or N)	Yes, 'Q' if Control
9.4.13	Danger Code			Ignored	No
9.4.14	Relevant Clinical Information			Ignored	No
9.4.15	Date/Time Specimen Received			Ignored	No
9.4.16	Specimen Descriptor	Text / Specy See Note 2		Yes	No
9.4.17	Ordering Physician			Ignored	No
9.4.18	Physician Phone Nb			Ignored	No



Table 12: Order record fields

ASTM field	Definition	Transmitted data	Field max. length	PML Receives	PML Sends
9.4.19	User Field 1	Specy See Note 2		Yes	No
9.4.20	User Field 2	Specy See Note 2		Yes	No
9.4.21	Laboratory Field 1	Specy See Note 2		Yes	No
9.4.22	Laboratory Field 2	Specy See Note 2		Yes	No
9.4.23	Date and Time Results reported or last modified			Ignored	No
9.4.24	Instrument Charge to Computer System			Ignored	No
9.4.25	Instrument Section ID			Ignored	No
9.4.26	Report Types			Ignored	No
9.4.27	Reserved field			Ignored	No
9.4.28	Location or Ward of Specimen Collection			Ignored	No
9.4.29	Nosocomial Infection Flag			Ignored	No
9.4.30	Specimen Service			Ignored	No
9.4.31	Specimen institution			Ignored	No



• **NOTE 3:** Field 9.4.3 «Sample ID»: Alphanumeric characters are accepted (0-9, A-Z). Spaces and punctuation are not allowed. Refer to Host specification document for each instrument connected for other limitations.

The information of «^Rack^Position» is only sent by the instrument.

• **NOTE 4:** Field 9.4.5 «Universal test ID»: Any Parameters or compatible Panels («See Special characteristics for HORIBA Medical data», page 12).

Example with Panels: «^^^DIF» («See Example of Order sent by Host», page 18).

List of compatible Panels: CBC, DIF, RET, CBR, DIR, NRBC (ERB), CBE, SPSEC (Slide + Stain).

Example with Parameters (Mandatory when the LIS sends the previous values):

«^^^WBC\^^^RBC\^^^HGB\^^^HCT\^^^MCV\^^^MCH\^^^MCHC\^^^RDW\^^^PLT\^^^MPV\^^^PCT\^^^PDW». «See Example of previous values (patient history) sent by host», page 18.

• **NOTE 5:** Do not send collection Date and Time to the workstation to avoid patient history calculation problem.

3.2.4. Result record

Table 13: Result record fields

ASTM field	Definition	Transmitted data	Field max. length	PML Receives	PML Sends
10.1.1	Record Type	R	1	Required	Required
10.1.2	Sequence Nb	1, 2, ...	3	Required	Required
10.1.3	Universal Test ID	^^^Parametername See Note 6	x	Required	Required
10.1.4	Data or Measurement Value	Test result (See «See Special characteristics for HORIBA Medical data», page 12)		Yes See Note 7	Yes
10.1.5	Unit	See Note 8	15	No	Yes
10.1.6	Reference Range			No	No



Table 13: Result record fields

ASTM field	Definition	Transmitted data	Field max. length	PML Receives	PML Sends
10.1.7	Result Abnormal Flag	Analytical flag See Note 9 L,H,LL,HH,>	2	No	Yes
10.1.8	Nature of Abnormality Testing			No	No
10.1.9	Result Status	W: Suspicion N: Rejected result M: Value input manually (V3.0 and above)	1	No	Yes
10.1.10	Date of Change in Normative Values or Units			No	No
10.1.11	Operator Identification		40	No	Yes
10.1.12	Date/Time Test Starting			No	No
10.1.13	Date/Time Test Completed	YYYYMMDDHHMMSS	14	Required	No
10.1.14	Instrument Identification		1	No	Yes



- NOTE 6: Field 10.1.3 «Universal test ID» had no length limitation.
- NOTE 7: Patient history (Delta check) calculation. “See Example of previous values (patient history) sent by host”, page 18 (Not validated for V1.0.0 software).
- NOTE 8: Field 10.1.5 «Units» ABX Pentra ML sends the unit in DOS characters, example «µ» is sent «æ».
- NOTE 9: Field 10.1.7 «Result Abnormal Flag»
L,H,LL,HH: Result above normal or panic ranges.
> : Result over instrument capacity (Dilution must be done).

3.2.5. Comment record

Table 14: Comments record fields

ASTM field	Definition	Transmitted data	Field max. length	PML Receives	PML Sends
11.1.1	Record Type	C	1	Yes	Required
11.1.2	Sequence Nb	1, 2, ...	3	Yes	Required
11.1.3	Comment Source			No	Yes
11.1.4	Comment Text	Text See Note 10	200	Yes	Yes
11.1.5	Comment Type	'I': comment is an alarm or a pathologic message. 'G' comment is a rule comment message.		No	Yes



- NOTE 10: Field 11.1.4 «Comment text» If the comment record is received after the patient record, then the comment is associated to the demographic. If the comment record is received after the order record, then the comment is associated to the report.

3.2.6. Query record (Request information order)

ABX Pentra ML request information for only one tube at the time: 1 Request information record for each tube.

For example:

Table 15: Example of Query for one tube

ABX Pentra ML
Host
<ENQ>
<ACK>
<STX>1H \^& PML P 1394-97 20031202104812<CR><ETX>19<CR><LF>
<ACK>
<STX>2Q 1 ^SID007 O<CR><ETX>B8<CR><LF>
<ACK>



Table 15: Example of Query for one tube

```
<STX>3L|1<CR><ETX>3C<CR><LF>
<ACK>
<EOT>
```

Table 16: Request information record fields

ASTM field	Definition	Transmitted data	Field max. length	PML Receives	PML Sends
12.1.1	Record Type	Q	1	No	Required
12.1.2	Sequence Nb	1	3	No	Required
12.1.3	Identifier	^Sample Id	16	No	Yes
12.1.4	End of identifier list			No	No
12.1.5	Universal Test ID			No	No
12.1.6	Time limits			No	No
12.1.7	Time max. limit			No	No
12.1.8	Time min. limit			No	No
12.1.9	Physician name			No	No
12.1.10	Telephone number			No	No
12.1.11	Reserve for user			No	No
12.1.12	Reserve for user			No	No
12.1.13	Status code	O: Query for test information	1	No	Yes Always 'O'

3.2.7. Terminator record

Table 17: Terminator record

ASTM field	Definition	Transmitted data	Field max. length	PML Receives	PML Sends
13.1.1	Record type	L	1	Required	Required
13.1.2	Sequence number	1	3	Required	Required
13.1.3	Termination code			Ignored	No

4. Special characteristics for HORIBA Medical data

4.1. CBC Data presentation

Table 18: CBC Data presentation

Parameter	English code	Standard Units	S.I. Units	mmol Units	Japanese Units
White Blood Cell	WBC	10 ³ /mm ³	10 ⁹ /L	10 ⁹ /L	10 ² /mm ³
Red Blood Cell	RBC	10 ⁶ /mm ³	10 ¹² /L	10 ¹² /L	10 ⁴ /mm ³
Hemoglobin	HGB	g/dL	g/L	mmol/L	g/dL
Hematocrit	HCT	%	L/L	L/L	%
Mean Corpuscular Volume	MCV	μm ³	fL	fL	μm ³
Mean Corpuscular Hemoglobin	MCH	pg	pg	fmol	pg
Mean Corpuscular Hemoglobin Concentration	MCHC	g/dL	g/L	mmol/L	g/dL
Red Distribution Width	RDW	%	%	%	%
Platelets	PLT	10 ³ /mm ³	10 ⁹ /L	10 ⁹ /L	10 ⁴ /mm ³
Mean Platelet Volume	MPV	μm ³	fL	fL	μm ³
Plateletcrit	PCT	%	10 ⁻² /L	10 ⁻² /L	%
Platelet Distribution Width	PDW	%	%	%	%

4.2. DIF Data presentation

Table 19: DIF Data presentation

Parameter	English code	Standard Units	S.I. Units	mmol Units	Japanese Units
White Blood Cell	WBC	10 ³ /mm ³	10 ⁹ /L	10 ⁹ /L	10 ² /mm ³
Red Blood Cell	RBC	10 ⁶ /mm ³	10 ¹² /L	10 ¹² /L	10 ⁴ /mm ³
Hemoglobin	HGB	g/dL	g/L	mmol/L	g/dL
Hematocrit	HCT	%	L/L	L/L	%
Mean Corpuscular Volume	MCV	μm ³	fL	fL	μm ³



Table 19: DIF Data presentation

Parameter	English code	Standard Units	S.I. Units	mmol Units	Japanese Units
Mean Corpuscular Hemoglobin	MCH	pg	pg	fmol	pg
Mean Corpuscular Hemoglobin Concentration	MCHC	g/dL	g/L	mmol/L	g/dL
Red Distribution Width	RDW	%	%	%	%
Platelets	PLT	10 ³ /mm ³	10 ⁹ /L	10 ⁹ /L	10 ⁴ /mm ³
Mean Platelet Volume	MPV	μm ³	fL	fL	μm ³
Plateletcrit	PCT	%	10 ⁻² /L	10 ⁻² /L	%
Platelet Distribution Width	PDW	%	%	%	%
Lymphocytes #	LYM#	10 ³ /mm ³	10 ⁹ /L	10 ⁹ /L	10 ² /mm ³
Lymphocytes %	LYM%	%	%	%	%
Monocytes #	MON#	10 ³ /mm ³	10 ⁹ /L	10 ⁹ /L	10 ² /mm ³
Monocytes %	MON%	%	%	%	%
Neutrophils #	NEU#	10 ³ /mm ³	10 ⁹ /L	10 ⁹ /L	10 ² /mm ³
Neutrophils %	NEU%	%	%	%	%
Eosinophils #	EOS#	10 ³ /mm ³	10 ⁹ /L	10 ⁹ /L	10 ² /mm ³
Eosinophils %	EOS%	%	%	%	%
Basophils #	BAS#	10 ³ /mm ³	10 ⁹ /L	10 ⁹ /L	10 ² /mm ³
Basophils %	BAS%	%	%	%	%
Atypical Lymphocytes #	ALY#	10 ³ /mm ³	10 ⁹ /L	10 ⁹ /L	10 ² /mm ³
Atypical Lymphocytes %	ALY%	%	%	%	%
Large Immature Cell #	LIC#	10 ³ /mm ³	10 ⁹ /L	10 ⁹ /L	10 ² /mm ³
Large Immature Cell %	LIC%	%	%	%	%
Lymphocyte Immature cell %	IML%	%	%	%	%
Lymphocyte Immature cell #	IML#	10 ³ /mm ³	10 ⁹ /L	10 ⁹ /L	10 ² /mm ³
Monocyte Immature cell %	IMM%	%	%	%	%
Monocyte Immature cell #	IMM#	10 ³ /mm ³	10 ⁹ /L	10 ⁹ /L	10 ² /mm ³
Granulocyte Immature cell %	IMG%	%	%	%	%
Granulocyte Immature cell #	IMG#	10 ³ /mm ³	10 ⁹ /L	10 ⁹ /L	10 ² /mm ³

4.3. DIR Data presentation

Table 20: DIR Data presentation

Parameter	English code	Standard Units	S.I. Units	mmol Units	Japanese Units
White Blood Cell	WBC	10 ³ /mm ³	10 ⁹ /L	10 ⁹ /L	10 ² /mm ³
Red Blood Cell	RBC	10 ⁶ /mm ³	10 ¹² /L	10 ¹² /L	10 ⁴ /mm ³
Hemoglobin	HGB	g/dL	g/L	mmol/L	g/dL
Hematocrit	HCT	%	L/L	L/L	%
Mean Corpuscular Volume	MCV	μm ³	fL	fL	μm ³
Mean Corpuscular Hemoglobin	MCH	pg	pg	fmol	pg
Mean Corpuscular Hemoglobin Concentration	MCHC	g/dL	g/L	mmol/L	g/dL
Red Distribution Width	RDW	%	%	%	%
Platelets	PLT	10 ³ /mm ³	10 ⁹ /L	10 ⁹ /L	10 ⁴ /mm ³
Mean Platelet Volume	MPV	μm ³	fL	fL	μm ³
Plateletcrit	PCT	%	10 ⁻² /L	10 ⁻² /L	%
Platelet Distribution Width	PDW	%	%	%	%
Lymphocytes #	LYM#	10 ³ /mm ³	10 ⁹ /L	10 ⁹ /L	10 ² /mm ³
Lymphocytes %	LYM%	%	%	%	%
Monocytes #	MON#	10 ³ /mm ³	10 ⁹ /L	10 ⁹ /L	10 ² /mm ³
Monocytes %	MON%	%	%	%	%
Neutrophils #	NEU#	10 ³ /mm ³	10 ⁹ /L	10 ⁹ /L	10 ² /mm ³
Neutrophils %	NEU%	%	%	%	%
Eosinophils #	EOS#	10 ³ /mm ³	10 ⁹ /L	10 ⁹ /L	10 ² /mm ³
Eosinophils %	EOS%	%	%	%	%
Basophils #	BAS#	10 ³ /mm ³	10 ⁹ /L	10 ⁹ /L	10 ² /mm ³
Basophils %	BAS%	%	%	%	%
Atypical Lymphocytes #	ALY#	10 ³ /mm ³	10 ⁹ /L	10 ⁹ /L	10 ² /mm ³
Atypical Lymphocytes %	ALY%	%	%	%	%
Large Immature Cell #	LIC#	10 ³ /mm ³	10 ⁹ /L	10 ⁹ /L	10 ² /mm ³



Table 20: DIR Data presentation

Parameter	English code	Standard Units	S.I. Units	mmol Units	Japanese Units
Large Immature Cell %	LIC%	%	%	%	%
Lymphocyte Immature cell %	IML%	%	%	%	%
Lymphocyte Immature cell #	IML#	10 ³ /mm ³	10 ⁹ /L	10 ⁹ /L	10 ² /mm ³
Monocyte Immature cell %	IMM%	%	%	%	%
Monocyte Immature cell #	IMM#	10 ³ /mm ³	10 ⁹ /L	10 ⁹ /L	10 ² /mm ³
Granulocyte Immature cell %	IMG%	%	%	%	%
Granulocyte Immature cell #	IMG#	10 ³ /mm ³	10 ⁹ /L	10 ⁹ /L	10 ² /mm ³
Reticulocytes #	RET#	10 ⁶ /mm ³	10 ¹² /L	10 ¹² /L	10 ⁴ /mm ³
Reticulocytes %	RET%	%	%	%	%
Corrected Reticulocyte Concentration	CRC	%	%	%	%
Reticulocytes (Low)	RETL%	%	%	%	%
Reticulocytes (Medium)	RETM%	%	%	%	%
Reticulocytes (High)	RETH%	%	%	%	%
Immature Reticulocytes	RETIMM	%	%	%	%
Mean Reticulocyte Volume	MRV	μm ³	fL	fL	μm ³
Mean Fluorescence Index	MFI	%	%	%	%
Immature Reticulocyte Fraction	IRF				
PIC	PIC				

4.4. RET Data presentation

Table 21: RET Data presentation

Parameter	English code	Standard Units	S.I. Units	mmol Units	Japanese Units
Red Blood Cell	RBC	10 ⁶ /mm ³	10 ¹² /L	10 ¹² /L	10 ⁴ /mm ³
Reticulocytes #	RET#	10 ⁶ /mm ³	10 ¹² /L	10 ¹² /L	10 ⁴ /mm ³
Reticulocytes %	RET%	%	%	%	%
Reticulocytes (Low)	RETL%	%	%	%	%

Table 21: RET Data presentation

Parameter	English code	Standard Units	S.I. Units	mmol Units	Japanese Units
Reticulocytes (Medium)	RETM%	%	%	%	%
Reticulocytes (High)	RETH%	%	%	%	%
Mean Reticulocyte Volume	MRV	μm ³	fL	fL	μm ³
Mean Fluorescence Index	MFI	%	%	%	%
Corrected Reticulocyte Concentration	CRC	%	%	%	%
Immature Reticulocytes	RETIMM	%	%	%	%
Immature Reticulocyte Fraction	IRF				
PIC	PIC				

4.5. CBR Data presentation

Table 22: CBR Data presentation

Parameter	English code	Standard Units	S.I. Units	mmol Units	Japanese Units
White Blood Cell	WBC	10 ³ /mm ³	10 ⁹ /L	10 ⁹ /L	10 ² /mm ³
Red Blood Cell	RBC	10 ⁶ /mm ³	10 ¹² /L	10 ¹² /L	10 ⁴ /mm ³
Hemoglobin	HGB	g/dL	g/L	mmol/L	g/dL
Hematocrit	HCT	%	L/L	L/L	%
Mean Corpuscular Volume	MCV	μm ³	fL	fL	μm ³
Mean Corpuscular Hemoglobin	MCH	pg	pg	fmol	pg
Mean Corpuscular Hemoglobin Concentration	MCHC	g/dL	g/L	mmol/L	g/dL
Red Distribution Width	RDW	%	%	%	%
Reticulocytes #	RET#	10 ⁶ /mm ³	10 ¹² /L	10 ¹² /L	10 ⁴ /mm ³
Reticulocytes %	RET%	%	%	%	%
Reticulocytes (Low)	RETL%	%	%	%	%
Reticulocytes (Medium)	RETM%	%	%	%	%
Reticulocytes (High)	RETH%	%	%	%	%
Mean Fluorescence Index	MFI	%	%	%	%



Table 22: CBR Data presentation

Parameter	English code	Standard Units	S.I. Units	mmol Units	Japanese Units
Mean Reticulocyte Volume	MRV	μm ³	fL	fL	μm ³
Corrected Reticulocyte Concentration	CRC	%	%	%	%
Immature Reticulocytes	RETIMM	%	%	%	%
Immature Reticulocyte Fraction	IRF				
Platelets	PLT	10 ³ /mm ³	10 ⁹ /L	10 ⁹ /L	10 ⁴ /mm ³
Mean Platelet Volume	MPV	μm ³	fL	fL	μm ³
Plateletcrit	PCT	%	10 ⁻² /L	10 ⁻² /L	%
Platelet Distribution Width	PDW	%	%	%	%
PIC	PIC				

4.6. ERB Data presentation

Table 23: ERB Data presentation

Parameter	English code	Standard Units	S.I. Units	mmol Units	Japanese Units
White Blood Cell	WBC	10 ³ /mm ³	10 ⁹ /L	10 ⁹ /L	10 ² /mm ³
Erythroblast %	ERB%	%	%	%	%
Erythroblast #	ERB#	10 ³ /mm ³	10 ⁹ /L	10 ⁹ /L	10 ² /mm ³
Corrected white blood cell	CWBC	10 ³ /mm ³	10 ⁹ /L	10 ⁹ /L	10 ² /mm ³

4.7. CBE Data presentation

Table 24: CBE Data presentation

Parameter	English code	Standard Units	S.I. Units	mmol Units	Japanese Units
White Blood Cell	WBC	10 ³ /mm ³	10 ⁹ /L	10 ⁹ /L	10 ² /mm ³
Red Blood Cell	RBC	10 ⁶ /mm ³	10 ¹² /L	10 ¹² /L	10 ⁴ /mm ³
Hemoglobin	HGB	g/dL	g/L	mmol/L	g/dL

Table 24: CBE Data presentation

Parameter	English code	Standard Units	S.I. Units	mmol Units	Japanese Units
Hematocrit	HCT	%	L/L	L/L	%
Mean Corpuscular Volume	MCV	μm ³	fL	fL	μm ³
Mean Corpuscular Hemoglobin	MCH	pg	pg	fmol	pg
Mean Corpuscular Hemoglobin Concentration	MCHC	g/dL	g/L	mmol/L	g/dL
Red Distribution Width	RDW	%	%	%	%
Platelets	PLT	10 ³ /mm ³	10 ⁹ /L	10 ⁹ /L	10 ⁴ /mm ³
Mean Platelet Volume	MPV	μm ³	fL	fL	μm ³
Plateletcrit	PCT	%	10 ⁻² /L	10 ⁻² /L	%
Platelet Distribution Width	PDW	%	%	%	%
Erythroblast %	ERB%	%	%	%	%
Erythroblast #	ERB#	10 ³ /mm ³	10 ⁹ /L	10 ⁹ /L	10 ² /mm ³
Corrected white blood cell	CWBC	10 ³ /mm ³	10 ⁹ /L	10 ⁹ /L	10 ² /mm ³

4.8. Default Configuration

Table 25: List of parameters by default

Parameter	English code	Standard Units	S.I. Units	mmol Units	Japanese Units
Metamyelocytes %	MET%	%	%	%	%
Metamyelocytes #	MET#	10 ³ /mm ³	10 ⁹ /L	10 ⁹ /L	10 ² /mm ³
Myelocytes %	MYE%	%	%	%	%
Myelocytes #	MYE#	10 ³ /mm ³	10 ⁹ /L	10 ⁹ /L	10 ² /mm ³
Promyelocytes %	PROMY%	%	%	%	%
Promyelocytes #	PROMY#	10 ³ /mm ³	10 ⁹ /L	10 ⁹ /L	10 ² /mm ³
Blasts %	BLA%	%	%	%	%
Blasts #	BLA#	10 ³ /mm ³	10 ⁹ /L	10 ⁹ /L	10 ² /mm ³
Promonocyte %	PROMO%	%	%	%	%



Table 25: List of parameters by default

Parameter	English code	Standard Units	S.I. Units	mmol Units	Japanese Units
Promonocyte #	PROMO#	10 ³ /mm ³	10 ⁹ /L	10 ⁹ /L	10 ² /mm ³
Prolymphocyte %	PROLY%	%	%	%	%
Prolymphocyte #	PROLY#	10 ³ /mm ³	10 ⁹ /L	10 ⁹ /L	10 ² /mm ³
Hyper Baso Lymphocyte %	LHYP%	%	%	%	%
Hyper Baso Lymphocyte #	LHYP#	10 ³ /mm ³	10 ⁹ /L	10 ⁹ /L	10 ² /mm ³
Plasmocyte %	PLAS%	%	%	%	%
Plasmocyte #	PLAS#	10 ³ /mm ³	10 ⁹ /L	10 ⁹ /L	10 ² /mm ³
Immature lymphocyte %	LYMAT%	%	%	%	%
Immature lymphocyte #	LYMAT#	10 ³ /mm ³	10 ⁹ /L	10 ⁹ /L	10 ² /mm ³
Sezary cell %	SEZ%	%	%	%	%
Sezary cell #	SEZ#	10 ³ /mm ³	10 ⁹ /L	10 ⁹ /L	10 ² /mm ³
Others %	OTH%	%	%	%	%
Others #	OTH#	10 ³ /mm ³	10 ⁹ /L	10 ⁹ /L	10 ² /mm ³
Bands %	BND%	%	%	%	%
Bands #	BND#	10 ³ /mm ³	10 ⁹ /L	10 ⁹ /L	10 ² /mm ³
Erythroblast %	ERB%	%	%	%	%
Erythroblast #	ERB#	10 ³ /mm ³	10 ⁹ /L	10 ⁹ /L	10 ² /mm ³
Granulocytes %	GRA %	%	%	%	%
Granulocytes #	GRA #	10 ³ /mm ³	10 ⁹ /L	10 ⁹ /L	10 ² /mm ³

Table 26: Additional parameters on User request

Parameter	English code	Standard Units	S.I. Units	mmol Units	Japanese Units
Myeloblast #	MYEB#	10 ³ /mm ³	10 ⁹ /L	10 ⁹ /L	10 ² /mm ³
Myeloblast %	MYEB%	%	%	%	%
Pelger Hüet #	PHUT#	10 ³ /mm ³	10 ⁹ /L	10 ⁹ /L	10 ² /mm ³
Pelger Hüet %	PHUT%	%	%	%	%
Hyper segmented Neutrophil #	HESN#	10 ³ /mm ³	10 ⁹ /L	10 ⁹ /L	10 ² /mm ³

Table 26: Additional parameters on User request

Parameter	English code	Standard Units	S.I. Units	mmol Units	Japanese Units
Hyper segmented Neutrophil %	HESN%	%	%	%	%
Hypo segmented Neutrophil #	HOSN#	10 ³ /mm ³	10 ⁹ /L	10 ⁹ /L	10 ² /mm ³
Hypo segmented Neutrophil %	HOSN%	%	%	%	%
Hyper granular Neutrophil	HEGN#	10 ³ /mm ³	10 ⁹ /L	10 ⁹ /L	10 ² /mm ³
Hyper granular Neutrophil %	HEGN%	%	%	%	%
Hypo granular Neutrophil	HOGN#	10 ³ /mm ³	10 ⁹ /L	10 ⁹ /L	10 ² /mm ³
Hypo granular Neutrophil %	HOGN%	%	%	%	%
Monoblast #	MONB#	10 ³ /mm ³	10 ⁹ /L	10 ⁹ /L	10 ² /mm ³
Monoblast %	MONB%	%	%	%	%
Macrophage #	MACP#	10 ³ /mm ³	10 ⁹ /L	10 ⁹ /L	10 ² /mm ³
Macrophage %	MACP%	%	%	%	%
Plasma cell #	PLAC#	10 ³ /mm ³	10 ⁹ /L	10 ⁹ /L	10 ² /mm ³
Plasma cell %	PLAC%	%	%	%	%
Reactive Lymphocyte #	RLYM#	10 ³ /mm ³	10 ⁹ /L	10 ⁹ /L	10 ² /mm ³
Reactive Lymphocyte %	RLYM%	%	%	%	%
Large Granular Lymphocyte #	LGL#	10 ³ /mm ³	10 ⁹ /L	10 ⁹ /L	10 ² /mm ³
Large Granular Lymphocyte %	LGL%	%	%	%	%
Lymphoblast #	LYMB#	10 ³ /mm ³	10 ⁹ /L	10 ⁹ /L	10 ² /mm ³
Lymphoblast %	LYMB%	%	%	%	%
Lymphoblast 1 #	LYMB1#	10 ³ /mm ³	10 ⁹ /L	10 ⁹ /L	10 ² /mm ³
Lymphoblast 1 %	LYMB1%	%	%	%	%
Lymphoblast 2 #	LYMB2#	10 ³ /mm ³	10 ⁹ /L	10 ⁹ /L	10 ² /mm ³
Lymphoblast 2 %	LYMB2%	%	%	%	%
Lymphoblast 3 #	LYMB3#	10 ³ /mm ³	10 ⁹ /L	10 ⁹ /L	10 ² /mm ³
Lymphoblast 3 %	LYMB3%	%	%	%	%
Burkitt Cell #	BURC#	10 ³ /mm ³	10 ⁹ /L	10 ⁹ /L	10 ² /mm ³
Burkitt Cell %	BURC%	%	%	%	%
Hairy Cell #	HARC#	10 ³ /mm ³	10 ⁹ /L	10 ⁹ /L	10 ² /mm ³



Table 26: Additional parameters on User request

Parameter	English code	Standard Units	S.I. Units	mmol Units	Japanese Units
Hairy Cell %	HARC%	%	%	%	%
Sezary Cell #	SEZ#	10 ³ /mm ³	10 ⁹ /L	10 ⁹ /L	10 ² /mm ³
Sezary Cell %	SEZ%	%	%	%	%
Mantle Cell #	MANC#	10 ³ /mm ³	10 ⁹ /L	10 ⁹ /L	10 ² /mm ³
Mantle Cell %	MANC%	%	%	%	%
MicromegaCaryoblast #	MIKB#	10 ³ /mm ³	10 ⁹ /L	10 ⁹ /L	10 ² /mm ³
MicromegaCaryoblast %	MIKB%	%	%	%	%
ESR	ESR	-	-	-	-
HbA1c	HbA1c	-	-	-	-
Coag	Coag	-	-	-	-
Group	Group	-	-	-	-

4.9. Alarms and Pathologies

4.9.1. ABX Pentra ML & Analytical alarms

ABX Pentra ML and analytical alarms are transmitted through the Comment record located after the Order record. If several pathologies are suspected they will be separated by the component delimiter.

4.9.2. Suspected pathologies

Suspected pathologies are transmitted through one Comment record located after the corresponding Result record. If several pathologies are suspected they will be separated by the component delimiter.

4.9.3. Suspicion and Reject

When one result is suspected abnormal or false, that means result is not reliable, the ABX Pentra ML returns a flag in field 10.1.9 ("See Result record", page 10).

4.9.4. Normal and Panic ranges

Flags when result exceeds Normal or Panic ranges are transmitted through field 10.1.7 ("See Result record", page 10).

5. Management of errors

5.1. During ABX Pentra ML transmission

During result transmission by ABX Pentra ML, if the host lost the transmission (Time-Out or EOT) the full message will be transmitted again.

5.2. During Host transmission

According to E-1381 protocol, error management of Time-out, Checksum and frame number, in case of none respect of these norms, will return NAK (or communication will be halted).

According to E-1394 protocol, all Orders without «Sample ID» will not be interpreted by ABX Pentra ML.

All too long fields will be cut to fit to ASTM field specified length.



6. Example of data frame

6.1. Example of Order sent by Host

- Patient ID: PID12345
- Patient Name: LASTNAME, FIRSTNAME
- Birthdate: 23/12/1964
- Prescriptor: Prescriptor
- Department: Location
- Sample ID (mandatory field): SID007
- Test (mandatory field): CBC

Table 27: Example of Order sent by Host

```
Host
ABX Pentra ML
<ENQ>
<ACK>
<STX>1H|\^&||ABX||||P|1394-97|20031202102713<CR><ETX>06<CR><LF>
<ACK>
<STX>2P|1||PID12345||LASTNAME^FIRSTNAME||19641223|M||||Prescriptor||||||Location<CR><ETX>D6<CR><LF>
<ACK>
<STX>3C|1||Patient Comment<CR><ETX>3C<CR><LF>
<ACK>
<STX>4O|1|SID007||^CBC|R||||A<CR><ETX>04<CR><LF>
<ACK>
<STX>5C|1||Order Comment<CR><ETX>65<CR><LF>
<ACK>
<STX>6L|1|N<CR><ETX>09<CR><LF>
<ACK>
<EOT>
```

6.2. Example of previous values (patient history) sent by host

Table 28: Example of previous values (patient history) sent by host

```
Host
ABX Pentra ML
<ENQ>
<ACK>
<STX>1H|\^&||PML||||P|1394-97|20040322101102<CR><ETX>11<CR><LF>
<ACK>
<STX>2P|1||PID001||NAME^FIRSTNAME||19641223|M||||PRESCRIPATOR||||||LOCATION<CR><ETX>14<CR><LF>
<ACK>
<STX>3C|1||PATIENT COMMENT|G<CR><ETX>36<CR><LF>
<ACK>
<STX>4O|1|2312001||^WBC|^RBC|^HGB|^HCT|^MCV|^MCH|^MCHC|^RDW|^PLT|^MPV|^PCT|^PDW|R||||BLOOD|||||<CR><ETX>05<CR><LF>
<ACK>
<STX>5R|1|^WBC|11.7|10E3/mm3|H||||ABX||20040322100222|0<CR><ETX>06<CR><LF>
<ACK>
<STX>6R|2|^RBC|4.59|10^6/mm3||||PentraDX||20040322100222|0<CR><ETX>F2<CR><LF>
<ACK>
<STX>7R|3|^HGB|13.8|g/dL||||PentraDX||20040322100222|0<CR><ETX>FD<CR><LF>
<ACK>
<STX>0R|4|^HCT|41.8|%||||PentraDX||20040322100222|0<CR><ETX>E5<CR><LF>
<ACK>
<STX>1R|5|^MCV|91|æm3||||PentraDX||20040322100222|0<CR><ETX>EE<CR><LF>
<ACK>
<STX>2R|6|^MCH|30.0|pg||||PentraDX||20040322100222|0<CR><ETX>8A<CR><LF>
<ACK>
<STX>3R|7|^MCHC|33.0|g/dL||||PentraDX||20040322100222|0<CR><ETX>41<CR><LF>
<ACK>
<STX>4R|8|^RDW|12.1|%||||PentraDX||20040322100222|0<CR><ETX>F2<CR><LF>
<ACK>
<STX>5R|9|^PLT|187|10E3/mm3||||PentraDX||20040322100222|0<CR><ETX>DE<CR><LF>
```



Table 28: Example of previous values (patient history) sent by host

```
<ACK>
<STX>6R|10|^^^MPV|10.4|æm3||||PentraDX||20040322100222|0<CR><ETX>85<CR><LF>
<ACK>
<STX>7R|11|^^^PCT|0.194|%||||PentraDX||20040322100222|0<CR><ETX>53<CR><LF>
<ACK>
<STX>0R|12|^^^PDW|18.8|%||H||||ABX||20040322100222|0<CR><ETX>41<CR><LF>
<ACK>
<STX>1L|1<CR><ETX>3A<CR><LF>
<ACK>
<EOT>
```

6.3. Example of Result sent by ABX Pentra ML

Table 29: Example of Result sent by ABX Pentra ML

```
ABX Pentra ML
Host
<ENQ>
<ACK>
<STX>1H|^&||PML||||P|1394-97|20031202123751<CR><ETX>1C<CR><LF>
<ACK>
<STX>2P|1||PID12345||LASTNAME^FIRSTNAME||19641223|M||||Prescriptor||||Location<CR><ETX>
D6<CR><LF>
<ACK>
<STX>3O|1|SID007^11^3||R|||||||<CR><ETX>42<CR><LF>
<ACK>
<STX>4C|1|P|Order Comment|G<CR><ETX>2E<CR><LF>
<ACK>
<STX>5C|2|P|Slide PLT abnormal morphology|G<CR><ETX>1E<CR><LF>
<ACK>
<STX>6R|1|^^^WBC|5.5|10E3/mm3||||20031204124839|ABX||0<CR><ETX>A3<CR><LF>
<ACK>
<STX>7R|2|^^^RBC|4.53|10^6/mm3||||20031204124839|ABX||0<CR><ETX>D5<CR><LF>
```

Table 29: Example of Result sent by ABX Pentra ML

```
<ACK>
<STX>0R|3|^^^HGB|13.0|g/dL||||20031204124839|ABX||0<CR><ETX>D6<CR><LF>
<ACK>
<STX>1R|4|^^^HCT|38.9|%||L||||20031204124839|ABX||0<CR><ETX>21<CR><LF>
<ACK>
<STX>2R|5|^^^MCV|86|æm3||||20031204124839|ABX||0<CR><ETX>DB<CR><LF>
<ACK>
<STX>3R|6|^^^MCH|28.8|pg||||20031204124839|ABX||0<CR><ETX>82<CR><LF>
<ACK>
<STX>4R|7|^^^MCHC|33.5|g/dL||||20031204124839|ABX||0<CR><ETX>2F<CR><LF>
<ACK>
<STX>5R|8|^^^RDW|13.9|%||||20031204124839|ABX||0<CR><ETX>E4<CR><LF>
<ACK>
<STX>6R|9|^^^PLT|150|10E3/mm3||||20031204124839|ABX||0<CR><ETX>BD<CR><LF>
<ACK>
<STX>7C|1||Macro Platelets|I<CR><ETX>FD<CR><LF>
<ACK>
<STX>0R|10|^^^MPV|11.5|æm3||H||||20031204124839|ABX||0<CR><ETX>B1<CR><LF>
<ACK>
<STX>1R|11|^^^PCT|0.173|%||||20031204124839|ABX||0<CR><ETX>32<CR><LF>
<ACK>
<STX>2R|12|^^^PDW|22.0|%||HH||||20031204124839|ABX||0<CR><ETX>91<CR><LF>
<ACK>
<STX>3L|1<CR><ETX>3C<CR><LF>
<ACK>
<EOT>
```



ABX Format

ASTM Format is recommended by HORIBA Medical for every new connection development. ABX Format is currently supported to be compliant with earlier ABX Pentra ML or existing connections.

1. Overview

- ABX format supports unidirectional or bidirectional connections.
- ABX format can have a different number of fields according to the transmitted items set up by the user (results, curves, flags, etc...) or according to the type of cycle.
- Fields sequence is not fixed.
- The result identifier is different according to the type of result: patient result («RESULT»), re-run result (RES-RR), QC result (QC-RES) etc... (“See Data transmitted by the host to the analyzer”, page 23).

2. Protocol description

2.1. Unidirectional mode

2.1.1. Typical unidirectional transmission from Instrument to Host

Table 30: Typical unidirectional transmission from ABX Pentra ML to Host

ABX Pentra ML	< >	Host	Comment
<STX> + RESULT + <ETX>	>		

2.1.2. Typical unidirectional transmission from ABX Pentra ML to Host with «SOH»\«EOT»

«SOH»\«EOT» option must be enabled on ABX Pentra ML.

Table 31: Typical unidirectional transmission with «SOH»\«EOT» from ABX Pentra ML to Host

ABX Pentra ML	< >	Host	Comment
<SOH>	>		ABX Pentra ML takes the Line
<STX> + RESULT + <ETX>	>		
	.		
	.		
	.		
<STX> + RESULT + <ETX>	>		
<EOT>	>		ABX Pentra ML frees the Line

2.2. Bidirectionnal mode

2.2.1. Typical bidirectionnal transmission from Host to ABX Pentra ML

Table 32: Typical transmission from Host to ABX Pentra ML

Host	< >	ABX Pentra ML	Comment
<SOH>	>		Host takes the Line
	<	<ENQ>	
<STX> + FILE + <ETX>	>		
	<	<ACK>	
	.		
	.		
	.		
<STX> + END + <ETX>	>		Host frees the Line
	<	<ACK>	

2.2.2. Typical bidirectionnal transmission from ABX Pentra ML to Host

Table 33: Typical transmission from ABX Pentra ML to Host

ABX Pentra ML	< >	Host	Comment
<SOH>	>		ABX Pentra ML takes the Line
	<	<ENQ>	
<STX> + RESULT + <ETX>	>		
	<	<ACK>	
	.		
	.		
	.		
<STX> + END + <ETX>	>		ABX Pentra ML frees the Line
	<	<ACK>	

2.3. Conflict management

Number of transmission if negative answer (NAK): 1

Timeout: 15s

In case of SOH/SOH conflict, priority is given to Host. After an adjustable delay (8s by default) and if Host has not re-sent a SOH, ABX Pentra ML tries to send SOH again until timeout. This is done until automatic disconnection max. time is reached.



3. Message structure

3.1. Lines structure

HEADER:

- STX
- Size + carriage return (Size: 5 bytes representing the total amount of the data except STX and ETX).
- Identifier followed by a Load Type + carriage return (Load: 8 character string preceded by a blank indicating the type of data).

VARIABLE PART:

- Identifier followed by the Information associated to the Load Type + carriage return (Identifier: 1 byte moving about \$21 to \$FF, it describes the information type which follows this indicator, always followed by a blank character \$20).
- Remainder of the other Identifiers and Information associated to the Load Type + carriage returns.
- Other Load Type blocs + Associated Information

POST-HEADER:

- Identifier followed by CheckSum + carriage return (CheckSum: Sum modulo 65536 of all characters except ETX, STX and all information about checksum (identifier - space - checksum - carriage return) in the hexadecimal format on 4 bytes, preceded by a blank character \$20).
- ETX

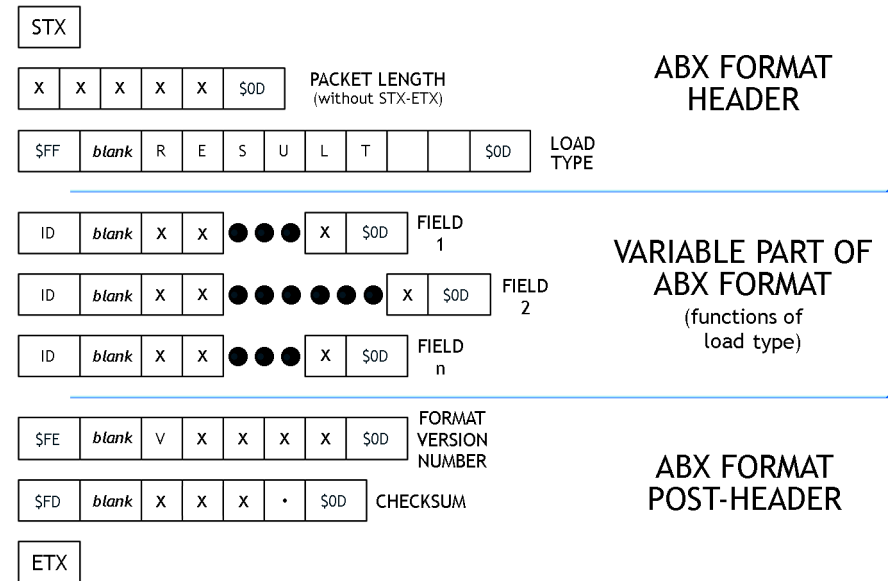

Diag.1: ABX format line structure

3.2. Control characters

Table 34: Standard control characters

Control String	Hexadecimal value
<ENQ>	\$05
<ACK>	\$06
<NAK>	\$15
<STX>	\$02
<ETX>	\$03
<CR>	\$0D
<LF>	\$0A
<EOT>	\$04
<SOH>	\$01



4. Data transmitted by the host to the analyzer

Data packet files are available only if the instrument has been set up with the remote controlled mode.

"FILE" request:

The data packet "FILE" is followed by \$75 or \$76 representing the patient file to obtain the type of test to be run on the corresponding sample.

Table 35: Example of transmission between Host and Instrument

Flow	Dataflow	Comments
Instrument>Host	\$01	Pentra sends SOH
Host>Instrument	\$05	Host responds ENQ
Instrument>Host	\$02\$FF FILE \$0D \$75 123456789012 \$0D \$03	Pentra sends STX + First Query Message + ETX...
Host>Instrument	\$06	Host responds ACK
Instrument>Host	Pentra sends STX + Next Query Message + ETX
Host>Instrument	\$06	Host responds ACK
Instrument>Host	Pentra sends STX + Last Query Message + ETX
Host>Instrument	\$06	Host responds ACK
Instrument>Host	\$0200043\$0D \$FF END \$0D \$03	Pentra sends STX + Free line + ETX
Host>Instrument	\$06	Host responds ACK

Each data packet "FILE" is preceded and followed by STX and ETX. Several requests of this type can be chained between a line bid and a line free in order to organize the grouping of the requests for the instruments equipped with an automatic sampling mode.

Table 36: Data packet strings

Data packet string	Use
FILE	Patient file
END	Line free message

Patient identification:

- All the described fields have a fixed size character string type and are completed with

blanks on the right side for the non-significant information.

- n= number
- c= character

Table 37: Identifier list (Host to Instrument)

Identifier	Correspondance	Example	Length	Format	Transmission	See Note
\$70 p	Analyzer number	01	2+2+1	Integers	required	
\$75 u	Id # or sample id.	1450302154275-42	2+16+1	String(16)	required	
\$76 v	Id. or patient name	SMITH Ronald	2+30+1	String(30)	required	
\$77 w	Birth date	YYYYMMDD	2+8+1	nnnnnnnn	optional	11
\$78 x	Age	7d or 4w or 10m or 54y or 100	2+3+1	String(3)	advised	12
\$79 y	Sex	0, 1 or 2	2+1+1	String(1)	advised	13
\$7A z	Origin	x	2+1+1	String(1)	optional	
\$7B {	Doctor	Dr Jones	2+15+1	String(15)	optional	
\$7C	Department	Cardiology	2+10+1	String(10)	optional	
\$7D }	Collection date	06/08/99 13h15	2+14+1	nn/nn/nn nnhnn	optional	
\$7E ~	Comments		2+32+1	String(32)	optional	
\$7F	Blood type	man / specy	2+16+1	String(16)	optional	14
\$80 ç	Analysis type	defined on1 character (see description). ' A ' : analysis CBC ' B ' : analysis DIF ' C ' : analysis RET ' E ' : analysis CBR ' F ' : analysis DIR ' G ' : no analysis (smearing SPS only) ' H ' : ERB ' I ' : CBE	2+1+1	String(1)	advised	5
\$89 ë	SPS smearing mode	ECC	2+3+1	String(3)	optional	16
\$8A è	SPS smearing profile	65G4	2+4+1	String(4)	optional	17
\$8B ï	Patient id.	200205125751	2+30+1	String(30)	advised	18





- **NOTE 11(\$77)**
No check on \$77 compared to \$78.
- **NOTE 12 (\$78)**
\$78 is a 3 characters string completed on the right side by blanks.
If age > 99 years, the 3 characters are used for the age without unit (ex: 102).
- **NOTE 13 (\$79)**
0 or Blank: Unspecified, 1: Male, 2: Female
- **NOTE 14 (\$7F)**
\$7F must be one of the instrument blood type list. If not, it is generated according to the age (\$78) or for adults according to the sex (\$79). In case of veterinary blood type, animal specy is given in this field (16 characters max).
- **NOTE 15 (\$80)**

Table 38: Test compatibility

Instrument	CBC	DIFF	RET	CBR	DIR	ERB	CBE	SPS
Pentra DX	X	X	X	X	X	X	X	
Pentra DX + SPS	X	X	X	X	X	X	X	X
Pentra DF	X	X						
Pentra DF + SPS	X	X						X

- **NOTE 16 (\$89)**
First character is blank +3 characters ECC:
E: Smearing
C: Staining
C: Criteria
When the file is received without \$89, the default type is applied.

Table 39: ECC combinations

E	C	C	Action
E	C	C	A slide for Smearing and Staining is done before test. A slide could be done after test, according to instrument Reflex testing conditions
E	C	blank	A slide for Smearing and Staining is done before test. Reflex testing conditions are inhibited
E	blank	blank	A slide for Smearing is done before test. Reflex testing conditions are inhibited

Table 39: ECC combinations

E	C	C	Action
E	blank	C	A slide for Smearing is done before test. A slide could be done after test, according to instrument Reflex testing conditions
blank	blank	C	No Slide Before test. A slide could be done after test, according to instrument Reflex testing conditions
blank	blank	blank	No Slide Before test. Reflex testing conditions are inhibited

- **NOTE 17 (\$8A)**
\$8A must be one of the Smearing profiles: drop volume, angle and speed.
- **NOTE 18 (\$8B)**
The Patient ID field can be transmitted, but it will be ignored by the instrument.



5. Data transmitted by the analyzer to the host

5.1. Packet type

The information described in the packet type allows the specification of the global message content: hematological routine results or statistic results.

Table 40: Packet type list

Data packet string (8 characters)	Use
RESULT	Hematological result transmission on a routine mode
RES-RR	Hematological result transmission on automatic re-sampling mode
RES-BLK	Hematological result transmission on blank cycle
QC-RES-H	Result transmission of a high level control blood
QC-RES-M	Result transmission of a median level control blood
QC-RES-L	Result transmission of a low level control blood
FILE	Patient file request
END	Connection end

5.2. Identifier list (Instrument to Host)

Table 41: Identifier list (Instrument to Host)

Identifier	Correspondance	Example	Length	Format	See Note
\$70 p	Analyzer number	01	2+2+1	Integers	
\$71 q	Analysis date and time	03/01/05 13h15mn31s	2+19+1	String(19)	
\$72 r	Analyzer run number	115 or 005CBC06	2+16+1	String(16)	
\$73 s	Analyzer sequence number	0128: analysis counter since instrument start	2+4+1	2+16+1	19
\$74 t	Sampling mode	M: manual (open tube) R: rack (close tube)	2+1+1	String(1)	
\$75 u	Id # or sample id.	1450302154275-42	2+16+1	String(16)	
\$76 v	Id. or patient name	SMITH Ronald	2+30+1	String(30)	

Table 41: Identifier list (Instrument to Host)

Identifier	Correspondance	Example	Length	Format	See Note
\$77 w	Birth date	16/03/72 or 03161972	2+8+1	nn/nn/nn or nnnnnnnn	11
\$78 x	Age	7d or 4w or 10m or 54y or 100	2+3+1	String(3)	20
\$79 y	Sex	0, 1 or 2	2+1+1	String(1)	21
\$7A z	Origin	x	2+1+1	String(1)	
\$7B {	Doctor	Dr Jones	2+15+1	String(15)	
\$7C	Department	Cardiology	2+10+1	String(10)	
\$7D }	Collection date	06/08/99 13h15	2+14+1	nn/nn/nn nnhnn	
\$7E ~	Comments		2+32+1	String(32)	
\$7F	Blood type	man / specy	2+16+1	String(16)	22
\$80 ç	Analysis type	defined on1 character (see description). 'A': analysis CBC 'B': analysis DIF 'C': analysis RET 'E': analysis CBR 'F': analysis DIR 'G': without analysis (smearing SPS only) 'H': ERB 'I': CBE	2+1+1	String(1)	
\$81 ü	Sample rack type	0: 10 positions 1: 15 positions 2: 32 positions	2+1+1	Integer	
\$82 é	Number of runs	0, 1, ...	2+1+1	Integer	
\$83 â	Operator code	Bob	2+3+1	String(3)	



• NOTE 19: (\$73)

Rack Mode: the sequence number indicates «number of runs on a rack + Rack test mode + Tube position» with number of runs from 0 to 9, Rack number from 01 to 99 (according to the Instrument settings), Test (CBC, DIF, RET, ERB, DIR, CBR or CBE), position from 01 to 10



Stat Mode: contains a single number on 4 digits. This number automatically increments on each new stat analysis.

- NOTE 20 (\$78)

\$78 is a 3 characters string completed on the right handside by «spaces». If age exceeded 99 years, the 3 characters of the string are used for the age without unit (example: 102).

- NOTE 21 (\$79)

0 or blank: Unspecified, 1: Male, 2: Female

- NOTE 22 (\$7F)

\$7F must be one of the instrument blood type list. If not, it will be generated according to the age (\$78) or for adults by the sex (\$79). In case of veterinary blood type, animal specy is given in this field.

5.2.1. Numerical result fields

- Units are standard units.
- If one parameter cannot be calculated by the analyzer, the field is replaced with --.--

Parameter status:

Following the numerical field, a first digit gives the counting rejection status or the suspicion, a second one gives the parameter value status according to high and low normalities, to high and low extreme values and to the overloading capacities.

Table 42: Identifier First digit

First digit (letter)	Correspondance
R	Parameter rejected for a counting default
S	Suspicious parameter value
D	Value obtained by dilution
blank	No anomaly observed

Table 43: Identifier Second digit

Second digit (letter)	Correspondance
B (french) or L (other languages)	Parameter < to the lower extreme value
b (french) or l (other languages)	Parameter < to the low normal value
blank	Parameter normal value

Table 43: Identifier Second digit

Second digit (letter)	Correspondance
h	Parameter > to the high normal value
H	Parameter > to the high extreme value
C	Platelet concentrate
O	Parameter exceeding the capacity

Example: 5.5 millions RBC with a counting error in the standard units:

\$32 \$20 \$30 \$35 \$2E \$35 \$30 \$52 \$68 \$0D or
«2 05.50Rh» + carriage return.

Table 44: CBC numerical result fields list

Identifier	Correspondance	Example	Format (Length)
\$21 !	WBC	07.40	2+String(7)+1
\$32 2	RBC	04.64	2+String(7)+1
\$33 3	Hgb	14.17	2+String(7)+1
\$34 4	Hct	43.95	2+String(7)+1
\$35 5	MCV	94.68	2+String(7)+1
\$36 6	MCH	30.53	2+String(7)+1
\$37 7	MCHC	32.24	2+String(7)+1
\$38 8	RDW	12.98	2+String(7)+1
\$40 @	PLT	00401	2+String(7)+1
\$41 A	MPV	07.94	2+String(7)+1
\$42 B	THT	0.318	2+String(7)+1
\$43 C	PDW	13.50	2+String(7)+1

Table 45: DIF numerical result fields list

Identifier	Correspondance	Example	Format (Length)
\$21 !	WBC	07.40	2+String(7)+1
\$22 "	Lymphocytes (#)	02.03	2+String(7)+1
\$23 #	Lymphocytes (%)	27.40	2+String(7)+1
\$24 \$	Monocytes (#)	00.70	2+String(7)+1
\$25 %	Monocytes (%)	09.40	2+String(7)+1



Table 45: DIF numerical result fields list

Identifier	Correspondance	Example	Format (Length)
\$28 (Neutrophils (#)	04.51	2+String(7)+1
\$29)	Neutrophils (%)	60.90	2+String(7)+1
\$2A *	Eosinophils (#)	00.13	2+String(7)+1
\$2B +	Eosinophils (%)	01.70	2+String(7)+1
\$2C ,	Basophils (#)	00.04	2+String(7)+1
\$2D -	Basophils (%)	00.60	2+String(7)+1
\$2E .	Atypical Lymphocytes (#)	00.11	2+String(7)+1
\$2F /	Atypical Lymphocytes (%)	01.49	2+String(7)+1
\$30 0	Large Immature Cells (#)	00.03	2+String(7)+1
\$31 1	Large Immature Cells (%)	00.43	2+String(7)+1
\$32 2	RBC	04.64	2+String(7)+1
\$33 3	Hgb	14.17	2+String(7)+1
\$34 4	Hct	43.95	2+String(7)+1
\$35 5	MCV	94.68	2+String(7)+1
\$36 6	MCH	30.53	2+String(7)+1
\$37 7	MCHC	32.24	2+String(7)+1
\$38 8	RDW	12.98	2+String(7)+1
\$40 @	PLT	00401	2+String(7)+1
\$41 A	MPV	07.94	2+String(7)+1
\$42 B	THT	0.318	2+String(7)+1
\$43 C	PDW	13.50	2+String(7)+1

Table 46: RET numerical result fields list

Identifier	Correspondance	Example	Format (Length)
\$32 2	RBC	04.64	2+String(7)+1
\$3B ;	Reticulocytes (#)	0656	2+String(7)+1
\$3C <	Reticulocytes (%)	01.41	2+String(7)+1
\$3D =	Reticulocytes Low (%)	80.34	2+String(7)+1
\$3E >	Reticulocytes Median (%)	14.96	2+String(7)+1
\$3F ?	Reticulocytes High (%)	04.90	2+String(7)+1

Table 46: RET numerical result fields list

Identifier	Correspondance	Example	Format (Length)
\$47 G	Retic Immatures	00.02	2+String(7)+1
\$48 H	Mean fluorescent index (%)	17.97	2+String(7)+1
\$49 I	Mean reticulocyte vol.	107.5	2+String(7)+1
\$4A J	Corrected ret. count (%)	01.38	2+String(7)+1
\$4C L	IRF	.0500	2+String(7)+1

Table 47: ERB numerical result fields list

Identifier	Correspondance	Example	Format (Length)
\$21 !	WBC	04.64	2+String(7)+1
\$BA	ERB%	07.20	2+String(7)+1
\$BB	ERB#	01.70	2+String(7)+1
\$BE	CWBC	24.30	2+String(7)+1

Table 48: CBR numerical result fields list

Identifier	Correspondance	Example	Format (Length)
\$21 !	WBC	07.40	2+String(7)+1
\$32 2	RBC	04.64	2+String(7)+1
\$33 3	Hgb	14.17	2+String(7)+1
\$34 4	Hct	43.95	2+String(7)+1
\$35 5	MCV	94.68	2+String(7)+1
\$36 6	MCH	30.53	2+String(7)+1
\$37 7	MCHC	32.24	2+String(7)+1
\$38 8	RDW	12.98	2+String(7)+1
\$3B ;	Reticulocytes (#)	.0656	2+String(7)+1
\$3C <	Reticulocytes (%)	01.41	2+String(7)+1
\$3D =	Reticulocytes Low (%)	80.34	2+String(7)+1
\$3E >	Reticulocytes Median (%)	14.96	2+String(7)+1
\$3F ?	Reticulocytes High (%)	04.90	2+String(7)+1
\$40 @	PLT	00401	2+String(7)+1



Table 48: CBR numerical result fields list

Identifier	Correspondance	Example	Format (Length)
\$41 A	MPV	07.94	2+String(7)+1
\$42 B	THT	0.318	2+String(7)+1
\$43 C	PDW	13.50	2+String(7)+1
\$47 G	Retic Immatures	00.02	2+String(7)+1
\$48 H	Mean fluorescent index (%)	17.97	2+String(7)+1
\$49 I	Mean reticulocyte vol.	107.5	2+String(7)+1
\$4A J	Corrected ret. count (%)	01.38	2+String(7)+1
\$4C L	IRF	.0500	2+String(7)+1

Table 49: CBE numerical result fields list

Identifier	Correspondance	Example	Format (Length)
\$21 !	WBC	07.40	2+String(7)+1
\$32 2	RBC	04.64	2+String(7)+1
\$33 3	Hgb	14.17	2+String(7)+1
\$34 4	Hct	43.95	2+String(7)+1
\$35 5	MCV	94.68	2+String(7)+1
\$36 6	MCH	30.53	2+String(7)+1
\$37 7	MCHC	32.24	2+String(7)+1
\$38 8	RDW	12.98	2+String(7)+1
\$40 @	PLT	00401	2+String(7)+1
\$41 A	MPV	07.94	2+String(7)+1
\$42 B	THT	0.318	2+String(7)+1
\$43 C	PDW	13.50	2+String(7)+1
\$BA	ERB%	07.20	2+String(7)+1
\$BB	ERB#	01.70	2+String(7)+1
\$BE	CWBC	24.30	2+String(7)+1

Table 50: DIR numerical result fields list

Identifier	Correspondance	Example	Format (Length)
\$21 !	WBC	07.40	2+String(7)+1
\$22 "	Lymphocytes (#)	02.03	2+String(7)+1
\$23 #	Lymphocytes (%)	27.40	2+String(7)+1
\$24 \$	Monocytes (#)	00.70	2+String(7)+1
\$25 %	Monocytes (%)	09.40	2+String(7)+1
\$28 (Neutrophils (#)	04.51	2+String(7)+1
\$29)	Neutrophils (%)	60.90	2+String(7)+1
\$2A *	Eosinophils (#)	00.13	2+String(7)+1
\$2B +	Eosinophils (%)	01.70	2+String(7)+1
\$2C ,	Basophils (#)	00.04	2+String(7)+1
\$2D -	Basophils (%)	00.60	2+String(7)+1
\$2E .	Atypical Lymphocytes (#)	00.11	2+String(7)+1
\$2F /	Atypical Lymphocytes (%)	01.49	2+String(7)+1
\$30 0	Large Immature Cells (#)	00.03	2+String(7)+1
\$31 1	Large Immature Cells (%)	00.43	2+String(7)+1
\$B4 ´	IML (%)	000.5	2+String(7)+1
\$B5 µ	IML (#)	00.05	2+String(7)+1
\$B6 ¶	IMM (%)	000.5	2+String(7)+1
\$B7 ·	IMM (#)	00.05	2+String(7)+1
\$B8 ¸	IMG (%)	000.5	2+String(7)+1
\$B9 ¹	IMG (#)	00.05	2+String(7)+1
\$32 2	RBC	04.64	2+String(7)+1
\$33 3	Hgb	14.17	2+String(7)+1
\$34 4	Hct	43.95	2+String(7)+1
\$35 5	MCV	94.68	2+String(7)+1
\$36 6	MCH	30.53	2+String(7)+1
\$37 7	MCHC	32.24	2+String(7)+1
\$38 8	RDW	12.98	2+String(7)+1
\$3B ;	Reticulocytes (#)	0656	2+String(7)+1
\$3C <	Reticulocytes (%)	01.41	2+String(7)+1



Table 53: Identifier list

Identifier	Parameter	Format	Length
\$54 T	WBC	String of characters	1 + 12x5 + 1 (max)
\$55 U	RBC	String of characters	1 + 7x5 + 1 (max)
\$56 V	PLT	String of characters	1 + 4x5 + 1 (max)
\$69 i	RET	String of characters	1 + 2x5 + 1 (max)

When there is no pathological message, length is: 2+0+1

Table 54: Pathological format description (English and other languages)

Population	Message	Signification	
WBC	LEU+ or LEU-	Leukocytosis Leukopenia	
	LYM+ or LYM-	Lymphocytosis Lymphopenia	
	NEU+ or NEU-	Neutrophilia Neutropenia	
	EOS+	Eosinophilia	
	MYEL	Myelemia	
	LIMC	Large Immature Cells	
	ALYM	Atypic Lymphocytes	
	LSHT	Left shift	
	NRBC	Nucleated Red Blood Cells	
	MON+	Monocytosis	
	BAS+	Basophilia	
	BLST	Blasts	
	RBC	ANEM	Anemia
		ANI1 or ANI2 or ANI3	Anisocytosis level 1 Anisocytosis level 2 Anisocytosis level 3
MIC1 or MIC2 or MIC3		Microcytes level 1 Microcytes level 2 Microcytes level 3	

Table 54: Pathological format description (English and other languages)

Population	Message	Signification	
	MAC1 or MAC2 or MAC3	Macrocytes level 1 Macrocytes level 2 Macrocytes level 3	
	MICR	Microcytosis	
	MACR	Macrocytosis	
	HCR1 or HCR2 or HCR3	Hypochromia level 1 Hypochromia level 2 Hypochromia level 3	
	CAGG	Cold agglutinin	
	ERYT	Erythrocytosis	
	Plt	THR+	Thrombocytosis
		THR-	Thrombopenia
		PLAG	Platelet aggregates
		SCEL	Small cells
	MICC	Microcytes	
	SCHI	Schizocytes	
	MAPL	Macro platelet	
Reticulocytes	IMMT	Immature reticulocytes	
	RET+ or RET-	Reticulocytosis Reticulopenia	
All populations	????	No interpretation	
	PANC	Pancytopenia	

Table 55: Pathological format description (French)

Population	Messages	Signification
GB	LEU+ or LEU-	Leucocytose Leucopénie
	LYM+ or LYM-	Lymphocytose Lymphopénie
	NEU+ or NEU-	Neutrophilie Neutropénie
	EOS+	Eosinophilie



Table 55: Pathological format description (French)

Population	Messages	Signification
	MYEL	Myélémie
	GCIM	Grandes Cellules Immatures
	LYAT	Lymphocytes atypiques
	FORG	Formule gauche
	MON+	Monocytose
	BAS+	Basophilie
	BLST	Blastes
GR	ANEM	Anémie
	ANI1 or ANI2 or ANI3	Anisocytose niveau 1 Anisocytose niveau 2 Anisocytose niveau 3
	MIC1 or MIC2 or MIC3	Microcytes niveau 1 Microcytes niveau 2 Microcytes niveau 3
	MAC1 or MAC2 or MAC3	Macrocytes niveau 1 Macrocytes niveau 2 Macrocytes niveau 3
	MICR	Microcytose
	MACR	Macrocytose
	HCR1 or HCR2 or HCR3	Hypochromie niveau 1 Hypochromie niveau 2 Hypochromie niveau 3
	AGGF	Agglutinine froide
	POLY	Erythrocytose
Pla	THR+	Thrombocytose
	THR-	Thrombopenie
	AGPL	Agrégats plaquettaires
	PECL	Petits éléments cellulaires
	MICC	Microcytes
	SCHI	Schizocytes
	MAPL	Macro plaquettes
Réticulocytes	IMMT	Réticulocytes immatures

Table 55: Pathological format description (French)

Population	Messages	Signification
	RET+ or RET-	Réticulocytose Réticulopénie
Toutes populations	????	Pas d'interprétation possible
	PANC	Pancytopenie

5.2.4. Histograms

5.2.4.1. Histograms

Histograms are transmitted on 128 channels, preceded by a blank. They are automatically rescaled to a 223 maximum amplitude value. The zero amplitude value is \$20, the maximum amplitude value is \$FF.

Extended format:

The extended format includes all the height information relative to each channel. It is constituted by a chart of 256 [RES] entries of 16 bits each. These 512 bytes chart is encoded before being transmitted. The format is as follows: identifier, space, encoding type on 8 characters (od or uuencode), space, encoded data size on 5 characters, space, data then carriage return.

5.2.4.2. Separation thresholds

It is the channel number (decimal value) enclosing areas on the histograms or on the matrix. Each threshold is transmitted on 3 bytes preceded by a blank.

5.2.4.3. Format description of the threshold transmission

A. WBC thresholds

Separation thresholds 1-2-3 allow the L1 flag determination. For the analyzers in LMG mode, the 4-5 thresholds allow the separation of the 3 populations Lymphocytes, Monocytes, Granulocytes.

Example 1: output format of the WBC curve thresholds for an LMG sampling. In this example, the analyzer does not send the calculation thresholds of the L1 flag.

«] 000 000 000 040 060» + carriage return.

Example 2: output format of the WBC curve thresholds for CBC and DIFF sampling. In



this 5parts DIFF analyzer, the LMG is not measured, the 4-5 thresholds are not significant.

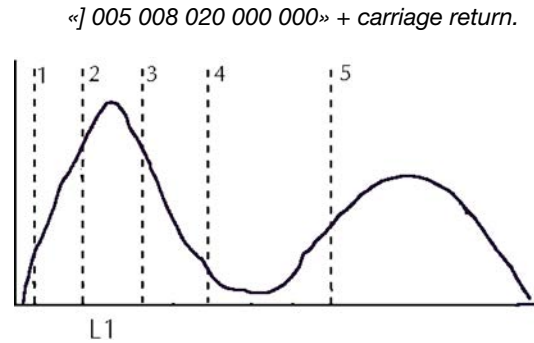

B. RBC thresholds

Separation thresholds 1-2 allow the calculation of the microcytic and macrocytic cell proportions.

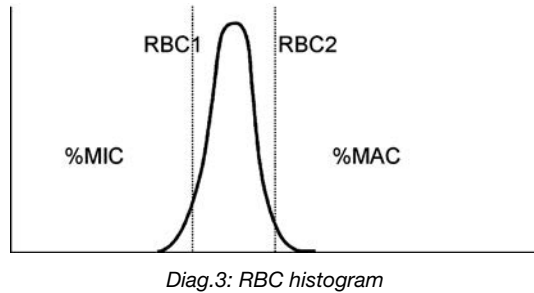

C. PLT thresholds

The threshold 1 is the number of the last channel used to calculate the PLT number.

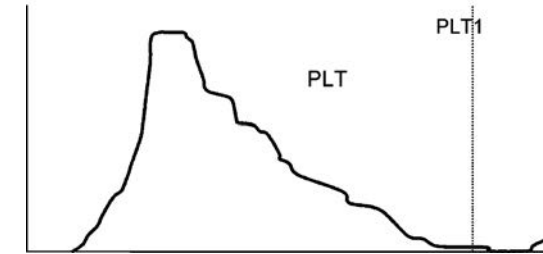

D. Basophil thresholds

Thresholds 1-2-3 allow the determination of the basophil proportion regarding the total number of WBCs.

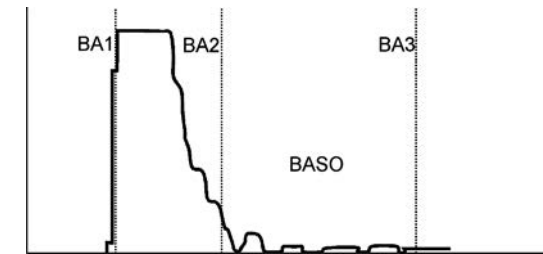

Table 56: Histogram format description

Identifier	Parameter	Format	Length
\$57 W	WBC	Amplitude of each channel	2+128+1
\$58 X	RBC	Amplitude of each channel	2+128+1
\$59 Y	Plt	Amplitude of each channel	2+128+1
\$5A Z	Basophils	Amplitude of each channel	2+128+1
\$5D]	WBC thresholds	5 thresholds	1+20+1

Table 56: Histogram format description

Identifier	Parameter	Format	Length
\$5E ^	RBC thresholds	2 thresholds	1+8+1
\$5F _	PLT thresholds	1 threshold	1+4+1
\$60 `	Basophil thresholds	3 thresholds	1+12+1

5.2.5. Matrix principles

A. ERB-RETIC Matrix principles

Screen bitmap: 2048 graphic bytes matrix are transmitted on 4096 ASCII bytes, preceded by a space. Each group of 2 ASCII bytes is the value of 1 graphic byte represented from the left to the right and from the top to the bottom of the screen. The matrix ERB-RET [128(ABS) x 128(RES)] is transmitted according to the same process.

B. LMNE matrix principles

Screen bitmap: 4096 graphic bytes matrix are transmitted on 8192 ASCII bytes, preceded by a space. Each group of 2 ASCII bytes is the value of 1 graphic byte represented from the left to the right and from the top to the bottom of the screen. The double matrix Lmne [128(ABS) x 256(RES)] is transmitted the same way.

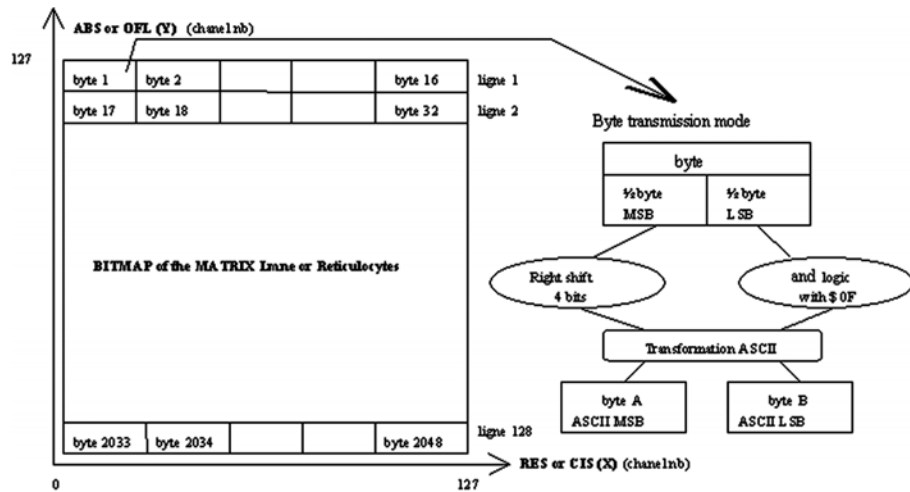

Diag.6: Matrix transmission

5.2.6. Matrix thresholds

A. Reticulocyte matrix thresholds

The 4 resistive thresholds are transmitted in the following order: R1, R2, R3, R4. Then the 4 fluorescent thresholds are following: F1, F2, F3, F4.

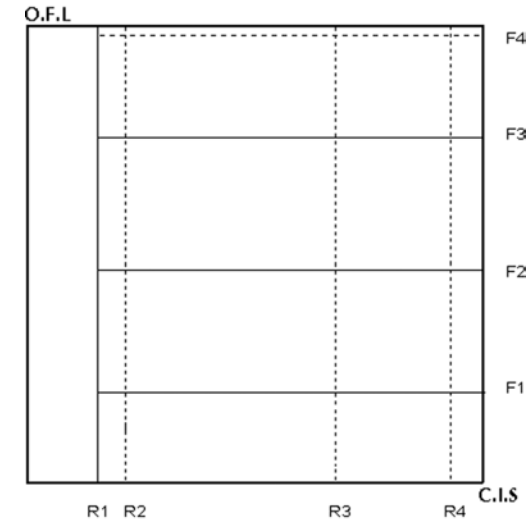

Diag.7: Reticulocytes matrix thresholds

B. ERB matrix thresholds

The 3 CIS thresholds are transmitted in the following order: R1, R2, R3.
Then the 3 OFL thresholds are following: F1, F2, F3.

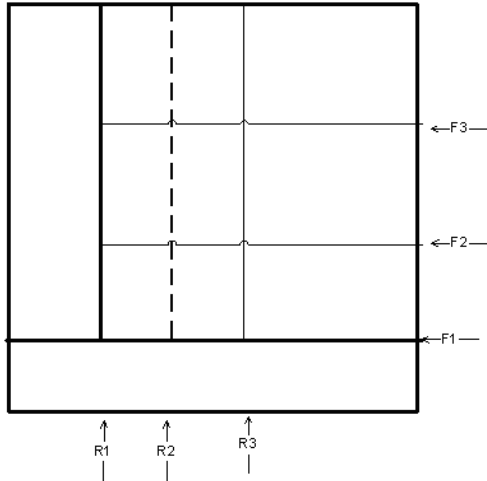

Diag.8: ERB matrix thresholds

C. LMNE matrix thresholds

The 12 resistive thresholds are transmitted in the following order: BFL, BFN, BFE, NG, ND, LG, LYA, LMN, LI, MI, MDI, IGI.

The 11 absorbance thresholds are transmitted in the following order: NL, NE, MND, LMI, MMD, IB, IH, IGIB, IGIH, GIB, GIH.

The width of the areas (002 channels) describing the proximity thresholds (ANE, AMN, ALN) are also transmitted.

Table 57: Channel Numbers for Resistive Thresholds

Thresholds	BFL	BFN	BFE	NG	ND	LG	LYA	LMN	LI	MI	MDI	IGI
Channel numbers	022	025	048	037	100	030	067	068	088	127	145	190

Table 58: Channel Numbers for Absorbance Thresholds

Thresholds	NL	NE	MND	LMI	MMD	IB	IH	IGIB	IGIH	GIB	GIH
Channel numbers	031	069	050	021	026	028	055	031	070	037	095

Table 59: Histogram & Matrix format description

Identifier	Parameter	Format	Length
\$5C \	Reticulocyte matrix	Screen bitmap	2+4096+1
\$C6 Æ	ERB matrix	Screen bitmap	2+4096+1
\$63 c	Double matrix Lmne	screen bitmap	2+8192+1
\$C8 È	Lmne matrix thresholds	12 RES thresholds /11 ABS thresholds 3 proximity thresholds	1+104+1
\$62 b	Reticulocyte matrix thresholds	4 CIS thresholds, 4 OFL thresholds	1+32+1
\$C9 É	ERB matrix thresholds	3 CIS thresholds, 3 OFL thresholds	1+24+1



Table 60: Other identifiers

Identifier	Correspondance	Format	Length
\$FB	Analyzer name	Character string	2+8+1
\$FC	Number	8 decimal bytes	2+8+1
\$FD	16 bits check sum value	4 hexadecimal bytes	2+4+1
\$FE	Version N° of Identifier list	String of characters: Vx.xx	2+5+1

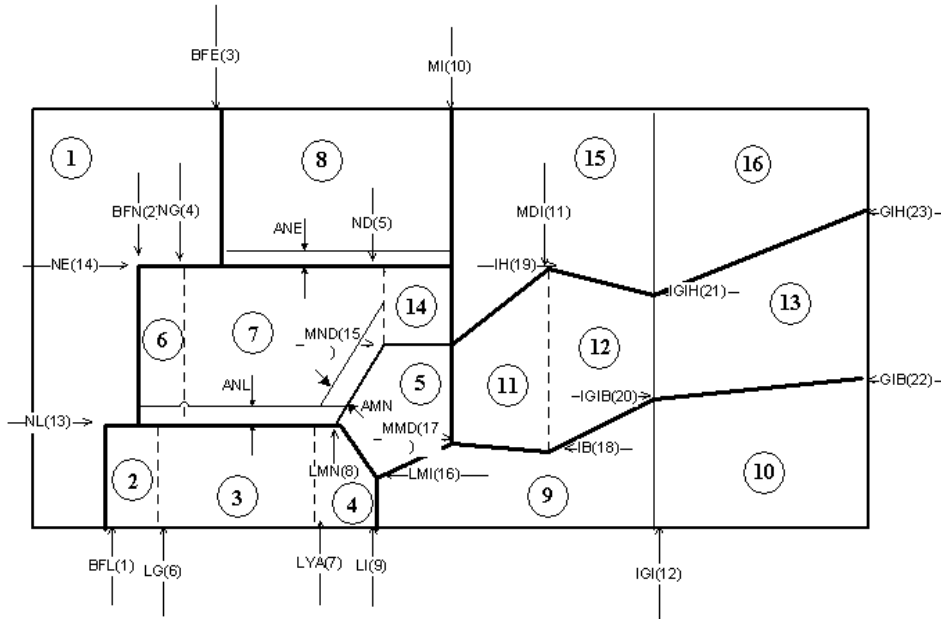

Diag.9: Lmne matrix thresholds

5.2.7. Other identifiers

Identifier \$FB: Identifies the analyzer type when communicating.

Identifier \$FC: This identifier allows the transmission of a number which can be an error number, a position number, a burn-in sequence number or a status in hexadecimal mode (Not available yet).

Identifier \$FD: Checksum value (see section on the message structure).

Identifier \$FE: The version number is linked to the development of the hematological message identifiers.



Identifier \$FC: The error list is dedicated to the "remote" mode.
For \$FB and \$FF, the strings having less than 8 characters are completed on the right side by blanks.



6. Query mode

- This optional mode allows the Host to selectively load the working list of each sample, once the barcode of the sample is read and a Query request is emitted by the instrument.
- This mode is of particular interest when the Host system manages several instruments analysers. In this case, the Query request transmitted by one of the analysers allows the Host system to load the working list on the instrument identified by the presence of the sample on this analyzer.
- The Query request is a 'FILE' type message and encapsulates 1 or several blocks surrounded by STX & ETX including the '\$75' type line followed by the identification of the sample (barcodes) (Maximum 10 Blocks per Query request).
- Transmission of the Query requests is carried out by instrument immediately after the tray of 10 samples is read. Only the samples identified by a barcode, and for which instrument did not receive a working list are transmitted in the QUERY request.
- The Host system has an answering delay which is adjustable on the analyzer (25 seconds by default). This delay is fixed after transmission of the last Query message, in order to return the message to load the working list of the sample or the samples concerned. Once the delay has been respected and in the case where no message is received by the analyzer, the rack of samples is automatically discharged without carrying out tests.
- The adjustment of the answering delay of the Host system is ideally fixed at 25 seconds by default. It is possible to change the value of this parameter, however, from 30 seconds on the analyser generates a supplementary waiting cycle of 30 seconds, or 2 waiting cycles from 60 seconds, involving a reduction of the analytical output capacity.

Table 61: QUERY request line structure

Identifier	Correspondance	Format	Length
\$FF ~	Data Packet	Character string	2+8+1
\$75 u	Identification #	Character string	2+16+1

Loading protocol of a working list in answer to a QUERY request:

Table 62: Instrument transmits to the Host a QUERY request

Flow	Dataflow	Comments
Instrument>Host	\$01	Pentra sends SOH
Host>Instrument	\$05	Host responds ENQ
Instrument>Host	\$02\$FF FILE \$OD \$75 123456789012 \$OD \$03	Pentra sends STX + First Query Message + ETX
Host>Instrument	\$06	Host responds ACK
Instrument>Host	Pentra sends STX + Next Query Message + ETX
Host>Instrument	\$06	Host responds ACK
Instrument>Host	Pentra sends STX + Last Query Message + ETX
Host>Instrument	\$06	Host responds ACK
Instrument>Host	\$02 00043\$OD \$FF END \$OD \$03	Pentra sends STX + Free line + ETX
Host>Instrument	\$06	Host responds ACK

Once the Host receives a Query type message, it returns a message to load the working list for the sample or samples concerned, respecting the delay programmed on the instrument (25 seconds by default).

